



**POWERING
PERFORMANCE.**

PRODUCT CATALOGUE

NEW ZEALAND



Welcome to the Trimax Family.

By fostering a culture of collaboration with our **Trimax Community**, our shared expertise enables us to consistently release industry leading products to the world.



BE PART OF THE JOURNEY...

f t i y v // **TRIMAXMOWERS.CO.NZ**

Our mowers are safety tested to comply with ISO (International Organisation for Standardisation) Safety Standards. So you can be sure your mower's as safe as it can be!

 **trimax**
MOWING SYSTEMS™

WHAT TESTS DO WE DO?



→ THROWN OBJECT:

Measured by surrounding the machine with specified targets, running over a standardised media (sand and stones) whilst running the mower and analysing hits in those areas. This results in thrown debris exiting the mower in a safe manner, meaning increased safety for the operator and bystanders.



→ BLADE IMPACT:

Measured by surrounding the mower with specified targets, and lowering it onto a high tensile steel bar with the blades spinning. Ensures that the blades do not fail in an unsafe manner and remain connected to the mower for increased bystander safety.



→ FINGER AND LIMB ACCESS:

Measured by probing all gaps and openings where there are moving parts with a replica arm/elbow/finger of specified dimensions. Results in unparalleled operator safety.



→ FOOT ACCESS TO CUTTING CHAMBER:

Measured by probing cutting chamber openings with a dummy foot of standard proportions. Results in increased protection for both operator and bystanders.



→ STRENGTH OF SURFACES THAT MAY BE USED AS STEPS:

Measured by loading with specific weights. Provides a safe platform from which to hook up the tractor.

We're serious about safety.

ISO International Standards ensure that products and services are safe, reliable and of good quality.

Our warranty claims are the lowest in the industry - **less than 1%**

The industry standard is over 2.5%. That means we build our mowers tough! Because of this, we're proud to offer our 3-year warranty on all of our mowers.

INDUSTRY LEADING 3 YEAR WARRANTY

We build mowers that last and we back that up with an industry leading 3-year warranty which also includes the spindles and gearboxes. Our robust design coupled with our experienced service and support network ensures minimum downtime and maximum productivity!



"We believe our service model is one of the best in the industry"

- NITESH PRASAD | Spare Parts Manager, Trimax Mowing Systems

→ GENUINE TRIMAX PARTS

Genuine Trimax parts have been tested and approved by us, so you can be sure of a better performance and a longer life from your machine.

→ TECHNICAL SUPPORT

Dedicated to providing one of the best customer service models in the industry, you'll be sure to get what you need quickly and efficiently.

→ NEXT DAY DELIVERY

We understand the implications of downtime and what that means for your profitability, so where possible we make sure you receive your orders overnight.



35 years of NZ History.

The birth of Trimax had a lot to do with modern day kiwifruit production, which was pioneered in New Zealand during the 1970s.

Whilst servicing the horticulture industry, Trimax gained demand for it's machines in parks and reserves because of the product's quality of cut and strong build. We have now grown to be a market leading brand around the world and take pride in supporting our customers and dealer networks as we work together to drive new mowing innovations.

- **BOB SIEVWRIGHT** | FOUNDER & OWNER OF TRIMAX MOWING SYSTEMS



"I first started working at Trimax in 1989. The team here have been continuously committed to developing world-class leading mowers. I am extremely passionate about selling Trimax products because they are reliable, incredibly robust and they do a fantastic job - I believe they are the best in the market. Today I am selling to the same customers I sold to 30 years ago...if that's not a testament to how special Trimax mowers are, then I don't know what is!"

- **IAN DIGGELMANN** | NZ SALES DEVELOPMENT MANAGER



Original Trimax Mowers Lineup



Original workshop



Exporter of the Year Award - 2003



The Trimax Story.

INNOVATION LIVES HERE.

Although kiwifruit production was the launching pad for Trimax, rapid product development has resulted in the broad range of Trimax mowers you see today. From world-class sports turf and golf courses to royal polo fields and estates, Trimax has delivered a powerful range of commercial products and a strong history of innovation. We're proud of our extensive global expertise and dealer network which allows us to service customers as quickly as when Trimax was just a small operation.

1983

Pride, Procut and Ezeemow disc mowers & the Procut S1 rotary roller mowers in production.



1989

Warlord and Sidewinder were released.



1992

First exports to Great Britain & awarded 'NZ Exporter of the Year.'



1995

First exports to the United States.



1997

FlailDek out front flail mower released.

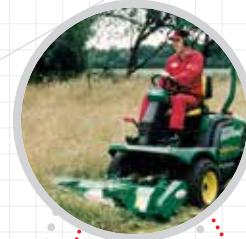

1981

First production of Ezeemow, Mowcraft & Mulchmasta flail mowers.



1991

Stealth S1 released.



1993

Topper S1 released & awarded 'NZ Exporter of the Year.'



1985

First exports to Australia and a dedicated research and development department established.



1997

Windsor Castle and surrounding grounds start using the Trimax ProCut for their maintenance.



1998

Trimax distribution warehouse opened in Great Britain.



2001

The Pegasus S1 is released. First Rotary roller mower in the USA.



2005

Set up of USA office in Georgia.



2010

Merlin dedicated golf and turf mower released.



2013

Set up of Australian office in Melbourne.



2016

The Stealth S3 is released. A new wing mower for sports and recreation mowing.



2019

Trimax Castor Wheel Mower, The Vulcan is released to the US market.



30th
ANNIVERSARY

2011

30th Anniversary of Trimax.



2008

Trimax Quattro Blades and X-WAM released.



2004

Trimax Lazerbladez™ released.



2014

Trimax Snake is released. A fully dedicated sports turf and golf mower.



2018

Release of ProCut S4, and LocTEK, Trimax's Stubless Roller Retention System.





The Striker has been built to withstand all conditions, a good solid mower. We had a test mow on delivery, the grass was about 150mm high and wet, it went great, made a good even cut leaving an even spread of cut grass, we thought it was the best mower we had ever seen.

- **IAN DUFTY** | Morrinsville, New Zealand



The school has had Trimax mowers for over 10 years now. They produce a pristine finish every time on both the cricket pitch and the rugby field. We're completely happy with them and we wouldn't look at another mower!

- **CHRIS HARRIS** | Tauranga Boys College, New Zealand















I've been mowing 30hrs a week for over 28 years and my Ezeemow still has the same gearbox. It produces a beautiful cut and if I had to, I'd replace it with the exact same model..no two ways about it!

- **STEVE DE BRUIN** | Grass Cutting Services, Tauranga, New Zealand





	STRIKER.....	12 - 14
	Rotary Mower	
	PROCUT S4.....	14 - 15
	Rotary Mower	
	PROCUT S4.....	16 - 17
	Single Roller Rotary Mower	
	PROCUT FM.....	18 - 19
	Rotary Mower	
	TOPPER.....	20 - 21
	Rotary Mower	
	STEALTH S3.....	22 - 23
	Rotary Mower	
	SNAKE S2.....	24 - 25
	Rotary Mower	
	PEGASUS S4.....	26 - 27
	Rotary Mower	
	X-WAM.....	28 - 29
	Rotary Mower	
	FLAILDEK FX.....	32 - 33
	Flail Mower	
	EZEEMOW FX.....	34 - 35
	Flail Mower	
	WARLORD S3.....	36 - 37
	Flail Mower	
	OFFSET GRAPHS.....	38
	Ezeemow FX and Warlord S3	

Common Product Options..... **39**

Trimax has a policy of continuous improvement, therefore models may change without notice.





ROTARY MOWERS

We build rotary roller mowers that produce the best cut possible whilst ensuring you spend less time and money on maintenance.

FAST BECOMING
THE MOWER OF
CHOICE AMONGST
GROUNDSMEN.

STRIKER

Trimax STRIKER is a multi-spindled rotary mower with extremely low maintenance requirements and is ideal for use on compact tractors.

The Trimax Striker series is designed to give a high cut quality and an excellent spread of clippings. Highly versatile, the Striker is capable of mowing grass 10 to 95mm. With an enclosed cutting chamber and a downward rear dispersion of clippings, the Striker has surpassed international safety standards making it one of the safest mowers on the market for use in public spaces.

Fitted with Trimax's exclusive LazerBladez™, the Striker can produce a cut and finish to rival that of a cylinder mower and is ideal for educational and sports facilities where presentation is key!

Talk to us today about the capabilities of Striker in your environment.



FITMENT

Rear 3-point linkage mounted compact tractor roller mower. Suitable for tractors with a minimum of 25hp.

DESIGN AND CONSTRUCTION

Trimax Striker incorporates a unique baffle design for improved grass distribution and less clumping. Engineered with a deep cut chamber, the Striker is able to deliver an even spread of clip from the back of the machine, creating a superb finish on a sports field.

Spindles are housed in maintenance-free fabricated steel housings with a large 6 bolt flange and each spindle has 2 Trimax LazerBladez™ mounted on spring steel blade beams.

The Striker uses a monocoque body construction from 5mm plate steel. With full width rollers front and rear the mower will not scalp over uneven ground. A comparably short mower front to rear coupled with a floating top link makes for excellent contour following. A proven and simple belt drive system eliminates the chance of expensive gearbox damage and is easily adjusted.

APPLICATIONS

✓ Municipality ✓ Horticulture ✓ Golf ✓ School ✓ Lifestyle ✓ Sports Field



The Striker takes full advantage of newer manufacturing technology such as laser cutting and CNC folding to make its components simpler, lighter and stronger. It's easy to adjust and maintain, the design is logical and it's a reliable, competent and strong machine.

- JIM MCEWEN | Senior Innovation Advisor of Trimax Mowing Systems



SPECIFICATIONS

	150	190
Cutting Width	1460mm (57")	1940mm (76")
Overall Width	1560mm (61")	2040mm (80")
Overall Length	1160mm (46")	1160mm (46")
Height	825mm (32")	830mm (32.5")
Cut Height Range	10 - 100mm (3/8" - 4")	10 - 100mm (3/8" - 4")
No. of Blade Spindles	3	4
Approx. Weight	312kg	384kg
Min Tractor HP	25hp	30hp



The Striker has been built to withstand all conditions, a good solid mower. We had a test mow on delivery, the grass was about 150mm high and wet, it went great, made a good even cut leaving an even spread of cut grass, we thought it was the best mower we had ever seen.

- IAN DUFTY | Morrisville, NZ

→ FEATURES



LOW COST OF OWNERSHIP

With only 4 grease points on the mower and with robust sealed spindles the Trimax Striker has incredibly low maintenance requirements.



LAZERBLADEZ™

Available in up-lift and flat formation to suit mowing requirements, the unique tilt forward design minimises hang back in tough conditions.



STRIPING CAPABLE

Fitted with full width front and rear rollers, the Striker can produce striped patterned turf for those spaces where presentation is key.



SAFETY FOR PUBLIC PLACES

Striker exceeds international safety standards, and can be used with confidence in public spaces, school sports fields and confined areas.



ADVANCED ENGINEERING

Trimax's meticulous design process combined with bespoke, innovative manufacturing technologies produce the most accurate rotary cutting in the market.



COMPACT TRACTOR SUITABLE

Able to be paired with tractors as low as 25hp the Striker is perfect for smaller budgets and compact tractors.



*OPTIONAL FEATURES

✓ HELICAL ROLLER SCRAPERS

For full description of Options go to Page 39 →





PROCUT/S4

A highly versatile roller mower, the PROCUT SERIES 4 is a multi-spindled roller mower designed to give high cut quality and a great spread of clippings.

The ProCut has been a successful part of the Trimax range for over 30 years, mowing parks and reserves, school grounds and sports fields around the world – from the grounds of Windsor Castle to your local community sports fields.

The ProCut Series 4, released in 2018, is excellence refined. Now even easier to operate and maintain than ever before, the ProCut still retains many of the aspects that propelled it to become one of the best sports mowers on the market.

Talk to us today about the capabilities of ProCut S4 in your environment.



ENGINEERED TO WITHSTAND
EVERYDAY USE IN THE
TOUGHEST COMMERCIAL
ENVIRONMENTS.

FITMENT

Rear 3-point linkage mounted tractor roller mower. Suitable for tractors with a minimum of 40hp.

DESIGN AND CONSTRUCTION

Trimax mowers are engineered with a higher number of spindles than comparable rotary mowers and have shorter blade beams which give more cuts per forward metre of travel and a fine cut. Roller bearings have been mounted inboard for better protection and are easily greasable through the side channels. The ProCut uses a monocoque body construction from 5mm plate steel. A comparably short mower front to rear and a floating top link ensures contour following on uneven ground. A proven and simple belt drive system eliminates the chance of expensive gearbox damage and is easily adjusted.

IMPROVEMENTS OVER THE PROCUT SERIES 3

Stand on covers make coupling to the tractor safer and new quick release latches and dual wash ports ensure easy maintenance and cleaning of the belt cavity. The new LocTEK stubless roller retention system and increased strength tri-bolt bearing housing reduces maintenance significantly. The 210 model now features extended side channels for improved long grass intake. RapidSET™ height adjustment and an improved PVK holding strip have also been introduced.

APPLICATIONS

- ✓ Municipality
- ✓ Horticulture
- ✓ Turf Farm
- ✓ Golf
- ✓ Racecourse
- ✓ School
- ✓ Lifestyle
- ✓ Sports Field
- ✓ Aviation
- ✓ Polo

→ FEATURES



LOCTEK

A stubless roller bearing system for vastly improved roller retention, alignment, bearing life and minimal maintenance.



STEADFAST SEALED SPINDLES

We've eliminated the tedious task of regular greasing. Covered by our 3-year warranty, maintenance costs are reduced, and productivity is enhanced.



LAZERBLADEZ™

Available in up-lift and flat formation to suit mowing requirements, the unique tilt forward design minimises hang back in tough conditions.



ADVANCED ENGINEERING

Trimax's meticulous design process combined with bespoke, innovative manufacturing technologies produce the most accurate rotary cut in the market.



RAPIDSET HEIGHT ADJUSTMENT

Clearly displayed stainless steel height indicators allow the easy adjustment of cut heights.



STAND ON COVERS

Enables safe and easy access to the rear of the tractor when coupling the mower. Quick release latches allow easy removal for cleaning and servicing.



DUAL WASH PORTS

Provides easy access for the removal of grass and drainage of water from the belt cavity while cleaning.



FULL WIDTH ROLLERS

Full width rollers minimise scalping in undulating conditions and allow mowing over kerbsides, bunkers and potholes. Also aides in striping.



SPECIFICATIONS	178	210	237	290
Cutting Width	1740mm (68.5")	2060mm (81")	2316mm (91")	2890mm (114")
Overall Width	1884mm (74")	2200mm (87")	2460mm (97")	3130mm (123")
Overall Length	1340mm (53")	1340mm (53")	1340mm (53")	1340mm (53")
Height	1085mm (43")	1085mm (43")	1085mm (43")	1085mm (43")
Cut Height Range	10 - 100mm ($\frac{3}{8}$ " - 4")	10 - 100mm ($\frac{3}{8}$ " - 4")	10 - 100mm ($\frac{3}{8}$ " - 4")	10 - 100mm ($\frac{3}{8}$ " - 4")
No. of Blade Spindles	3	3	4	5
Approx. Weight	511kg	608kg	641kg	770kg
Min Tractor HP	40hp	45hp	50hp	60hp

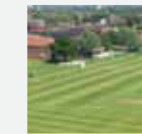

The ProCut is a great mower. I mow 19 schools at 40mm and the schools always comment on how nice the grounds look. I mow fast and the spread is great. I'd recommend Trimax to anyone!

- ALLEN COE Schools Contractor, NZ



*OPTIONAL FEATURES

- ✓ QUATTRO BLADE SYSTEM
- ✓ SINGLE ROLLER (SEE PAGE 18)
- ✓ FRONT MOUNT
- ✓ ANTI-BOUNCE SKIDS
- ✓ HELICAL ROLLER SCRAPERS
- ✓ STORAGE AND LIGHTING KIT
- ✓ GALVANIZED SURFACE COATING

For full description of Options go to Page 39 →

TRANSFORMS LONG
GRASSED APPLICATIONS TO
EVEN FIELDS OF GREEN

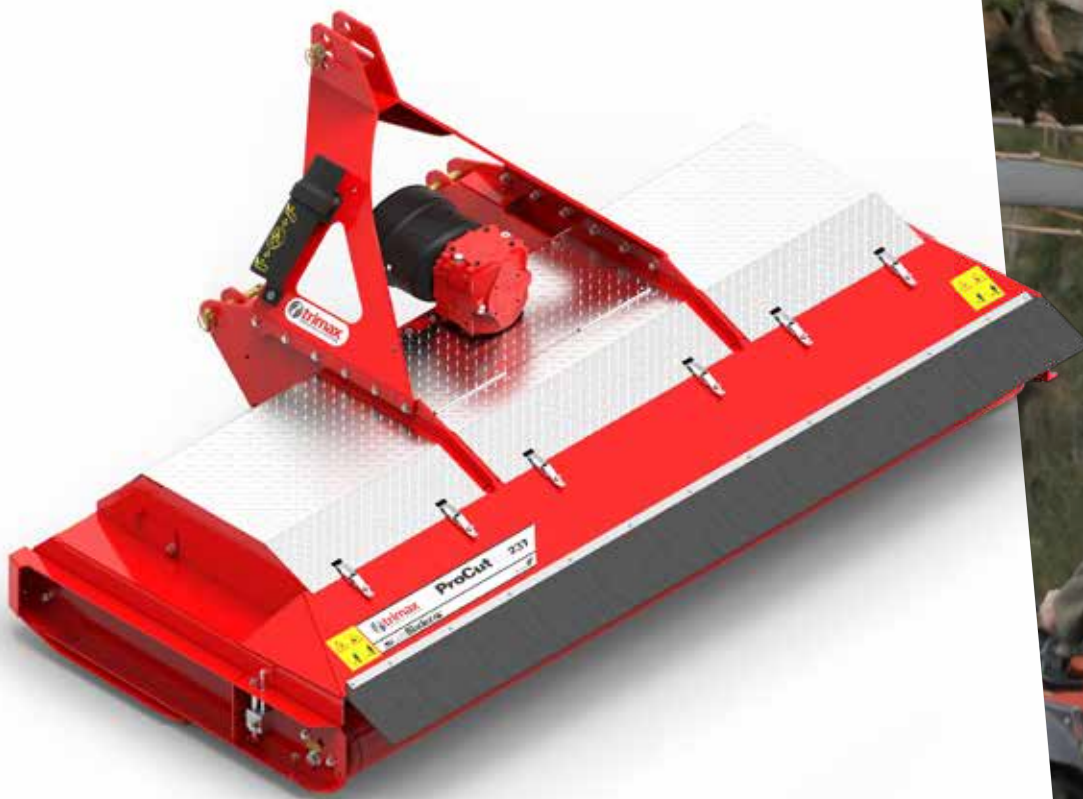

PROCUT **S4**

SINGLE ROLLER

The original PROCUT found phenomenal success in long grass applications such as orchard mowing applications due to its rigid construction, low maintenance and manoeuvrability.

The Single Roller ProCut Series 4 mower is a long grass mower that gives a superior cut and finish to that of a Slasher. Engineered with a low body profile and increased under deck clearance the ProCut provides excellent clipping distribution and features a rear roller which runs smoothly over bumps provides anti-scalp protection.

The open front of the mower, which runs on trailing skids, allows the intake of long grass making it an excellent option for mowing orchards, racetracks and irregularly maintained areas.

Talk to us today about the capabilities of ProCut S4 in your environment.



FITMENT

Rear 3-point linkage mounted tractor roller mower. Suitable for tractors with a minimum of 40hp.

DESIGN AND CONSTRUCTION

Trimax mowers are engineered with a higher number of spindles than comparable rotary mowers and have shorter blade beams which give more cuts per forward metre of travel and a fine cut. Roller bearings have been mounted inboard for better protection and are easily greasable through the side channels. The ProCut uses a monocoque body construction from 5mm plate steel. A comparably short mower front to rear and a floating top link ensures contour following on uneven ground. A proven and simple belt drive system eliminates the chance of expensive gearbox damage and is easily adjusted.

IMPROVEMENTS OVER THE PROCUT SERIES 3

Stand on covers make coupling to the tractor safer and new quick release latches and dual wash ports ensure easy maintenance and cleaning of the belt cavity. The new LocTEK stubless roller retention system and increased strength tri-bolt bearing housing reduces maintenance significantly. RapidSET™ height adjustment and an improved PVK holding strip have also been introduced.

APPLICATIONS

✓ Municipality ✓ Horticulture ✓ Racecourse ✓ Lifestyle ✓ Aviation

FEATURES



LOCTEK

A stubless roller bearing system for vastly improved roller retention, alignment, bearing life and minimal maintenance.



STEADFAST SEALED SPINDLES

We've eliminated the tedious task of regular greasing. Covered by our 3-year warranty, maintenance costs are reduced, and productivity is enhanced.



LAZERBLADEZ™

Available in up-lift and flat formation to suit mowing requirements, the unique tilt forward design minimises hang back in tough conditions.



ADVANCED ENGINEERING

Trimax's meticulous design process combined with bespoke, innovative manufacturing technologies produce the most accurate rotary cutting in the market.



RAPIDSET HEIGHT ADJUSTMENT

Clearly displayed stainless steel height indicators allow the easy adjustment of cut heights.



STAND ON COVERS

Enables safe and easy access to the rear of the tractor when coupling the mower. Quick release latches allow easy removal for cleaning and servicing.



DUAL WASH PORTS

Provides easy access for the removal of grass and drainage of water from the belt cavity while cleaning.



FULL WIDTH REAR ROLLER

Full width rear roller minimises scalping in undulating conditions and allows mowing over kerbsides, bunkers and potholes. Also aides in striping.



SPECIFICATIONS	178	210	237	290
Cutting Width	1742mm (69")	2060mm (81")	2316mm (91")	2890mm (114")
Overall Width	1884mm (74")	2200mm (87")	2460mm (97")	3130mm (123")
Overall Length	1340mm (53")	1340mm (53")	1340mm (53")	1340mm (53")
Height	1085mm (43")	1085mm (43")	1085mm (43")	1085mm (43")
Cut Height Range	10 - 100mm ($\frac{3}{8}$ " - 4")	10 - 100mm ($\frac{3}{8}$ " - 4")	10 - 100mm ($\frac{3}{8}$ " - 4")	10 - 100mm ($\frac{3}{8}$ " - 4")
No. of Blade Spindles	3	3	4	5
Approx. Weight	476kg	568kg	596kg	731kg
Min Tractor HP	40hp	45hp	50hp	60hp



The ProCut is over and above what we ever expected. We knew we needed more than just a slasher, the fine cut and even dispersion of the ProCut leaves a fantastic presentation.

- DALE COOK | Copelands Estate, Warragul, VIC, AUSTRALIA



*OPTIONAL FEATURES

- ✓ HELICAL ROLLER SCRAPERS
- ✓ STORAGE AND LIGHTING KIT
- ✓ GALVANIZED SURFACE COATING

For full description of Options go to Page 39 →



PROCUT//FM

The front mounted version of the ever-popular rear linkage mounted Trimax PROCUT.

The Trimax ProCut FM is a robust machine engineered to withstand everyday use in the toughest commercial environments yet will deliver a clean cut – every time.

In operation the front-mounted ProCut Series 4 rides on the ground on its front wheels and rear roller. The front castor wheels and rear roller follow ground contours allowing easy manoeuvrability and prevent scalping. With out-front mowing the need for the operator to look behind is reduced and the tractor wheels do not flatten the uncut grass.

Talk to us today about the capabilities of ProCut FM in your environment.



TAKES A PADDOCK
TO HIGH LEVELS OF
PRESENTATION.

FITMENT

Front 3-point linkage mounted tractor roller mower. Suitable for tractors with a minimum of 30-45hp.

DESIGN AND CONSTRUCTION

Trimax mowers are engineered with a higher number of spindles than comparable rotary mowers and have shorter blade beams which give more cuts per minute and therefore a fine cut. Roller bearings have been mounted inboard for better protection and are easily greasable through the side channels. The ProCut uses a monocoque body construction from 5mm plate steel. A comparably short mower front to rear and a floating top link ensures contour following on uneven ground. A proven and simple belt drive system eliminates expensive gearbox damage common in shaft-drive mowers, and is easily adjusted.

IMPROVEMENTS OVER THE PROCUT SERIES 3

Stand on covers make coupling to the tractor safer and new quick release latches and dual wash ports ensure easy maintenance and cleaning of the belt cavity. The new LocTEK stubless roller retention system and increased strength tri-bolt bearing housing reduces maintenance significantly. RapidSET™ height adjustment and an improved PVK holding strip have also been introduced.

APPLICATIONS

- ✓ Municipality
- ✓ Horticulture
- ✓ Turf Farm
- ✓ Golf
- ✓ Racecourse
- ✓ School
- ✓ Lifestyle
- ✓ Sports Field
- ✓ Aviation
- ✓ Polo



SPECIFICATIONS	178	210	237	290
Cutting Width	1740mm (68.5")	2060mm (81")	2316mm (91")	2890mm (114")
Overall Width	1884mm (74")	2200mm (87")	2460mm (97")	3130mm (123")
Overall Length	1340mm (53")	1340mm (53")	1340mm (53")	1340mm (53")
Height	1085mm (43")	1085mm (43")	1085mm (43")	1085mm (43")
Cut Height Range	10 - 100mm ($\frac{3}{8}$ " - 4")	10 - 100mm ($\frac{3}{8}$ " - 4")	10 - 100mm ($\frac{3}{8}$ " - 4")	10 - 100mm ($\frac{3}{8}$ " - 4")
No. of Blade Spindles	3	3	4	5
Approx. Weight	511kg	608kg	641kg	770kg
Min Tractor Size	40	45	50	60

→ FEATURES



LOCTEK

A stubless roller bearing system for vastly improved roller retention, alignment, bearing life and minimal maintenance.



STEADFAST SEALED SPINDLES

We've eliminated the tedious task of regular greasing. Covered by our 3-year warranty, maintenance costs are reduced, and productivity is enhanced.



LAZERBLADEZ™

Available in up-lift and flat formation to suit mowing requirements, the unique tilt forward design minimises hang back in tough conditions.



ADVANCED ENGINEERING

Trimax's meticulous design process combined with bespoke, innovative manufacturing technologies produce the most accurate rotary cutting in the market.



RAPIDSET HEIGHT ADJUSTMENT

Clearly displayed stainless steel height indicators allow the easy adjustment of cut heights.



STAND ON COVERS

Enables easy coupling of the mower to the tractor



DUAL WASH PORTS

Provides easy access for the removal of grass and drainage of water from the belt cavity while cleaning.



FULL WIDTH ROLLER

A large diameter rear roller on the ProCut follows contours and supports the mower across its entire width, providing excellent anti-scalp protection. A pair of castor wheels support the front of the mower.

★★★

INDUSTRY LEADING WARRANTY

3 YEAR

INCLUDES SPINDLES & GEARBOXES

EXPERIENCED SERVICE & SUPPORT NETWORK

*OPTIONAL FEATURES

- ✓ HELICAL ROLLER SCRAPERS
- ✓ QUATTRO BLADES
- ✓ REAR MOUNT

For full descriptions of Options go to Page 39 →

TOPPER

The Trimax TOPPER cuts pasture quickly and efficiently and has multiple features enabling its use on lower hp tractors.

Small diameter blades turning at high speed on the Topper mean more cuts per forward metre of travel than comparable pasture toppers, giving a finer cut and increasing regrowth and pasture quality. Very high under-body clearance and the open deck design allows good flow of grass into the mowing deck and a clean ejection of cut grass.

Powered by a proven belt drive system, the Trimax Topper is more efficient than comparable shaft drive pasture toppers. Short in body from front to rear and mounting close to the tractor the Topper is able to be used on smaller tractors for large cut widths and also enables a smaller turning radius for easier access into tight corners.

Talk to us today about the capabilities of Topper in your environment.



TRIMAX CUTTING
INNOVATION FOR
INCREASED PRODUCTION.

FITMENT

Rear 3-point linkage mounted mower for tractors with a minimum of 50hp

DESIGN AND CONSTRUCTION

Trimax Topper has 4 cast iron spindle housings. Each Topper spindle has 2 LazerBladez™ mounted on a spring steel blade beam. A floating head stock and replaceable wear skids give good contour following ability. An easily adjustable belt drive protects the gearbox from impact damage. The Topper uses a monocoque body construction from 5mm plate steel.

APPLICATIONS

✓ Agriculture ✓ Aviation



SPECIFICATIONS

	237	282
Cutting Width	2316mm (91")	2740mm (107")
Overall Width	2460mm (97")	2880mm (113")
Overall Length	1316mm (51")	1240mm (48")
Cut Height Range	20 - 160mm (¾" - 6¼")	20 - 160mm (¾" - 6¼")
No. of Blade Spindles	4	4
Approx. Weight	575kg	625kg
Min Tractor HP	50hp	60hp

The Benefits of Pasture Topping.

- ✓ IMPROVES FEED QUALITY
- ✓ INCREASES FARM PROFITABILITY
- ✓ INCREASES MS PRODUCTION
- ✓ PROMOTES FASTER RE-GROWTH



We use the Topper to keep up the quality of the grass behind the cows. The farm tends to grow a lot of grass early on in the season and it's hard to control, even with silage, so we top to keep the quality up. We get a nice clean cut which means you get good regrowth. I wouldn't buy anything else.

- IAN WILCOX | Farmer, Matamata, NZ

→ FEATURES



LOW HP REQUIREMENTS

Open deck design for grass processing, efficient belt drive system and a short mower front to rear allows for use on lower HP tractors.



LAZERBLADEZ™

Available in up-lift and flat formation to suit mowing requirements, the unique tilt forward design minimises hang back in tough conditions.



ADVANCED DESIGN

Short front to rear and mounting close to the tractor allowing better manoeuvrability. High under body clearance and open deck design for increased grass production.

*OPTIONAL FEATURES

For full description of Options go to Page 39 →



ANTI-BLOCK SYSTEM

High tensile spindles feature anti-wrap pins preventing frustrating blockages around spindles in extreme conditions.



*REAR ROLLER

The Topper is fitted with a rear roller, which ensures that in undulating environments you'll have increased protection from scalping.



STEALTH/S3

The STEALTH SERIES 3 has been designed to give a higher quality of cut, operate in a wider range of conditions, be safer, more robust, easier to operate and take less time to maintain than any previous STEALTH.

Backed by 30 years' of experience in the market, the concept of Stealth Series 3 was born from the demand of our customers for a mower that was more versatile in terms of long grass performance and more user friendly for both the operator and the workshop.

Backed by our industry leading 3-year warranty and our parts and technical support team, we know the Stealth Series 3 to be the best linkage wing mower for passive and active turf in the market.

Ask us how Stealth Series 3 can transform your environment.



MARKET LEADING CUT,
FINISH AND VERSATILITY.



FITMENT

Rear 3-point linkage mounted wide area roller mower suitable for tractors with a minimum of 70hp.

DESIGN AND CONSTRUCTION

Stealth Series 3 features 5 spindles (3 on the main body, 1 on each wing) for a finer cut than comparable width rotary mowers. The spindles are housed in maintenance-free fabricated steel housings with a large 6 bolt flange. Stealth's wings have up and down float for contour following ability and fold up (using hydraulic rams) to reduce mower width to 2.4m for road travel.

The Stealth uses a monocoque body construction from 5mm plate steel. Skids fitted to the outside of the wings are made from wear resistant steel for 3x longer life. A proven and simple belt drive system eliminates the chance of expensive gearbox damage and is easily adjusted.

IMPROVEMENTS OVER THE STEALTH SERIES 2

We've reduced the need for greasing through the introduction of new features such as SteadFast maintenance free spindles and composite maintenance free bushes. Stealth wing locks can now be operated from inside the tractor cab. Modifications have been made to the cutting chamber and the baffle design for higher quality of cut and easy cleaning.

APPLICATIONS

✓ Municipality ✓ Golf ✓ School ✓ Sports Field ✓ Aviation ✓ Turf Farm ✓ Racecourse

→ FEATURES



LOCTEK

A stubless roller bearing system for vastly improved roller retention, alignment, bearing life and minimal maintenance.



EASY HEIGHT ADJUSTMENT

Clearly displayed stainless steel height indicators allow the easy adjustment of cut heights without having to raise or lower the wings.



LOW MAINTENANCE

Operators are no longer required to grease hinge points and spindles on a daily basis and can spend more time mowing and less time on maintenance.



STAND ON COVERS

Enables safe and easy access to the rear of the tractor when coupling to the mower. Quick release latches allow easy removal for cleaning and servicing.



LAZERBLADEZ™

Available in up-lift and flat formation to suit mowing requirements, the unique tilt forward design minimises hang back in tough conditions.



EASY TO CLEAN

The improved belt chamber design results in easy cleaning, with the front openings allowing any grass to be easily washed or removed.



ANTI-WEAR SKIDS

Anti-wear skids reduce wear on side channels when operating in rough or uneven terrain.



GREATER MOWING VERSATILITY

The improved cutting chamber and baffle design directs airflow from the blades out and over the rear roller for a better cut and spread.



*GALVANIZED SURFACE COATING

Provides added protection against corrosion in coastal environments with high salt concentrations or high fertiliser usage.

*OPTIONAL FEATURES

- ✓ INDIVIDUAL WING LIFT
- ✓ HELICAL ROLLER SCRAPERS
- ✓ STORAGE AND LIGHTING KIT
- ✓ QUATTRO BLADES
- ✓ SERVICE STANDS

For full description of Options go to Page 39 →



SPECIFICATIONS

340

Cutting Width	3400mm (134")
Transport Width	2416mm (95")
Overall Width	3550mm (140")
Overall Length	2416mm (95.2")
Height	1205mm (47.5")
Cut Height Range	10 - 90mm (3/8" - 3 1/2")
No. of Blade Spindles	5
Approx. Weight	995kg
Min Tractor HP	70hp



The Stealth has brilliant decks with excellent grass dispersion and minimal greasing required. We can just jump in and cut grass!

- ROSS HAMNER | Downer, Auckland, NZ



SNAKE // **S2**

The Trimax SNAKE is used on some of the most prestigious golf courses around the world. The cutting system has been studied by the Sports Turf Institute of New Zealand and declared to produce a cut of equal quality to cylinder mowers however with the versatility and reliability of our famous rotary design.

An accumulation of over 35 years of Trimax innovation, engineering and customer insight the Snake has been designed specifically for sports turf and golf courses. We've seamlessly combined our world class cut quality and articulation capabilities and believe we've created the best sports turf rotary mower in the world. Built for agility, incredibly robust and extremely low maintenance the Trimax Snake won't fail to impress.

Talk to us today about the capabilities of Snake in your environment.



WORLD CLASS
CUT QUALITY
AND ARTICULATION.

FITMENT

Trailed PTO driven multi-deck roller mower suitable for tractors with a minimum of 35hp. Recommended minimum of 50-60hp for Snake 3.2m and 60-70hp for Snake 4m

DESIGN AND CONSTRUCTION

Each of Trimax Snake's three mowing decks have spindles fitted with LazerBladez™ that have very high spindle speeds which increase the number of cuts per forward metre of travel giving a finer cut than comparable rotary mowers. Folding for transport and easily towed behind a compact tractor, the Snake is a cost effective alternative to traditional and expensive self-propelled options. Engineered with a low centre of gravity and with transport locks, road transport of the Snake is safe and easy. The Snake uses a monocoque body construction from 5mm plate steel. A proven and simple belt drive system eliminates the chance of expensive gearbox damage. Automatic belt tensioners ensure maximum drive to the blades at all times.

IMPROVEMENTS OVER THE SNAKE SERIES 1

The Snake Series 2 includes the new Trimax LocTEK stubless roller bearing retention system. The roller thickness has been increased to 5mm. The Snake now features replaceable axle stubs, a 90 degree rotatable jack stand and maintenance free pivot bushes.

APPLICATIONS

✓ Municipality ✓ Sports Field ✓ School ✓ Turf Farm ✓ Golf



SPECIFICATIONS

	320	400
Cutting Width	3234mm (127")	3985mm (157")
Overall Width	3372mm (133")	4110mm (162")
Overall Length	3500mm (138")	3500mm (138")
Transport Width	2100mm (82½")	2140mm (84¼")
Transport Height	1860mm (73")	2232mm (88")
Cut Height Range	10 - 100mm (¾" - 4")	10 - 100mm (¾" - 4")
No. of Blade Spindles	9	11
Approx. Weight	1280kg	1580kg
Min Tractor HP	35hp	40hp
Recommended HP	50 - 60hp	60 - 70hp



The first time I saw the Snake cut the grass I was really impressed at the speed and the striping finish. I'd recommend the Snake to anyone.

- ROY | Head Groundsman, Hampton Downs, NZ

FEATURES



LOCTEK

A stubless roller bearing system for vastly improved roller retention, alignment, bearing life and minimal maintenance.



AUTOMATIC BELT TENSIONERS

Automatic belt tensioners eliminate the need for belt adjustments and improves drive to the spindles and blades.



LAZERBLADEZ™

Available in up-lift and flat formation to suit mowing requirements the unique tilt forward design minimises hang back in tough conditions.



ZERO TURN

Allows continuous cutting while turning sharply for maximum productivity.



LOW MAINTENANCE

SteadFast sealed spindles have eliminated the tedious task of regular greasing. Snake Series 2 now also features maintenance free pivot bushes.



QUIKLIFT

QuikLIFT enables decks to be raised slightly for traversing paths without the need to disengage the PTO. Also aids in striping.



ARTICULATION ABILITY

With three articulating decks the Snake has the ability to follow contours.



FULL WIDTH ROLLERS

Full width rollers minimise scalping in undulating conditions and allow mowing over kerbsides, bunkers and potholes. Also aids in striping.



EASY HEIGHT ADJUSTMENT

Clearly displayed stainless steel height indicators allow the easy adjustment of cut heights without having to raise or lower the wings.

*OPTIONAL FEATURES

- ✓ ROAD KIT
- ✓ REMOTE UNLOCK
- ✓ ANTI-BOUNCE SKIDS
- ✓ HELICAL ROLLER SCRAPERS
- ✓ ROAD RATED TYRE

For full description of Options go to Page 39 →

PEGASUS//S4

The PEGASUS has established itself globally as the benchmark in wide-area mowing for parks, reserves, polo grounds, sports fields and turf farms.

The Trimax Pegasus was the world's first multi-deck roller mower and has been a successful part of the Trimax range for more than 17 years. The Pegasus has articulation capacity and is engineered to be incredibly robust for full-time commercial use.

Available in 4.9m, 6.1m and 7.2m widths the Pegasus Series 4 is our newest and lowest maintenance version of the trailed mower. With its wide cutting widths and ability to mow at speeds up to 15kms per hour on flat terrain, the Pegasus is one extremely efficient mower.

Talk to us today about the capabilities of Pegasus Series 4 in your environment.



THE BENCHMARK
IN WIDE AREA MOWING.

FITMENT

Trailed PTO driven wide area mower suitable for tractors with a minimum of 50hp.

DESIGN AND CONSTRUCTION

Pegasus has 3 multi-spindle double roller mowing decks on a roadworthy chassis that folds to 2.5m for road transport. Mowing decks have a physical safety lock and a safety lanyard for travel in the raised position. Pegasus comes standard with mudguards, lights and drawbar safety chains.

With Trimax LazerBladez™ and multiple spindles with shorter blade beams the Pegasus gives more cuts per forward metre of travel and produces a finer cut than comparable rotary mowers. The Pegasus uses a monocoque body construction from 5mm plate steel. A proven and simple belt drive system eliminates the chance of expensive gearbox damage and is easily adjusted.

IMPROVEMENTS OVER THE PEGASUS SERIES 3

The Pegasus Series 4 includes the new Trimax LocTEK stubless roller bearing retention system, and reduced grease points resulting in a 35% reduction in maintenance costs. Other improvements include RapidSET™ height adjustment, easily replaceable side channel bolts, and a waterproof lighting loom.

APPLICATIONS

- ✓ Municipality
- ✓ Horticulture
- ✓ Golf
- ✓ School
- ✓ Lifestyle
- ✓ Sports Field
- ✓ Aviation
- ✓ Turf Farm
- ✓ Racecourse
- ✓ Polo



SPECIFICATIONS	493	610	722
Cutting Width	4926mm (194")	6074mm (293")	7235mm (285")
Overall Width	5082mm (200")	6230mm (245")	7366mm (290")
Overall Length	4375mm (172")	4375mm (172")	4375mm (172")
Transport Width	2500mm (98")	2500mm (98")	2500mm (98")
Transport Height	2600mm (102")	3200mm (126")	3800mm (150")
Cut Height Range	10 - 100mm ($\frac{3}{8}$ " - 4")	10 - 100mm ($\frac{3}{8}$ " - 4")	10 - 100mm ($\frac{3}{8}$ " - 4")
No. of Blade Spindles	9	11	13
Approx. Weight	2180kg	2409kg	2700kg
Min Tractor HP	50hp	65hp	75hp
Recommended HP	75 - 85hp	95 - 105hp	110 - 120hp

722
Available in
Galv only

→ FEATURES



LOCTEK

A stubless roller bearing system for vastly improved roller retention, alignment, bearing life and minimal maintenance.



SUSPENSION

The Pegasus is fitted with a Duratorque Suspension System capable of highway speeds.



LAZERBLADEZ™

Available in up-lift and flat formation to suit mowing requirements, the unique tilt forward design minimises hang back in tough conditions.



ROAD TRANSPORTABLE

Equipped with a roadworthy chassis the Pegasus is capable of being towed at highway speeds (subject to local road regulations).



LOW MAINTENANCE

We've introduced new features such as our SteadFast sealed spindles and long life synthetic bushes which has reduced maintenance by 35%.



FULL WIDTH ROLLERS

Full width rollers minimise scalping in undulating conditions allow mowing over kerbsides and bunkers and potholes. Also aides in striping.



RAPIDSET HEIGHT ADJUSTMENT

Clearly displayed stainless steel height indicators allow the easy adjustment of cut heights without having to raise or lower the wings.



WHEELS RUN ON CUT GRASS

As the rear deck is located between the rear transport wheels, grass is not flattened by wheels prior to mowing, a feature unique to Trimax.

INDUSTRY LEADING WARRANTY

3
YEAR

INCLUDES SPINDLES & GEARBOXES

EXPERIENCED SERVICE & SUPPORT NETWORK

*OPTIONAL FEATURES

- ✓ INDIVIDUAL LIFT SYSTEM
- ✓ QUATTRO BLADE SYSTEM
- ✓ REMOTE UNLOCK
- ✓ HELICAL ROLLER SCRAPERS
- ✓ ELECTRIC BRAKES
- ✓ ANTI-BOUNCE SKIDS
- ✓ QUIKLIFT
- Only available on Pegasus 493 and 610 models
- ✓ ROAD REGISTRATION LIGHTING KIT
- ✓ SPARE TYRE KIT
- ✓ TURF TYRES
- ✓ GALVANIZED SURFACE COATING
- Only available on Pegasus 610 and 722 models

For full description of Options go to Page 39 →

X-WAM

The X-WAM has superior contour-following abilities based on the unique combination of five individual floating decks on an articulated axis.

With the potential to cut 13 hectares per hour and the ability to perform zero-turns without having to lift any of the mower decks, the X-WAM will increase your productivity and efficiency using only one tractor, one driver, and one mower.

Providing an even discharge of clippings and with the ability to mow in wet conditions and produce a cylinder-like patterned finish, X-WAM is the ultimate wide area mower.

Talk to us today about the capabilities of X-WAM in your environment.



THE ULTIMATE IN WIDE
AREA MOWING WHEN
QUALITY COUNTS.



FITMENT

Trailed PTO driven wide area mower suitable for tractors with a minimum of 100hp.

DESIGN AND CONSTRUCTION

X-WAM is available as a kit to add to a Pegasus 610, or as a complete model. The X-WAM consists of 2 decks and a chassis, and can be joined with a Pegasus chassis for a total of 5 decks. All the decks can be folded and retracted to 2.7m for road transport. Decks compact down to lower the centre of gravity so the machine is more stable on the road.

With Trimax LazerBladez™ and multiple spindles with shorter blade beams the X-WAM gives more cuts per forward metre of travel and a finer cut than comparable rotary mowers. The X-WAM uses a monocoque body construction from 5mm plate steel. A proven and simple belt drive system eliminates the chance of expensive gearbox damage and is easily adjusted.

APPLICATIONS

- ✓ Turf Farm



The X-WAM follows contours like no other 10-metre mower. The freedom of movement between its multiple decks and their full-width rollers allow articulation unique for a mower this wide.

- JIM MCEWEN | Senior Innovation Advisor of Trimax Mowing Systems



SPECIFICATIONS

10400

Cutting Width	10410mm (410")
Overall Width	10540mm (415")
Overall Length	5830mm (229")
Transport Width	2740mm (108")
Transport Height	4450mm (177")
Cut Height Range	10 - 100mm (3/8" - 4")
No. of Blade Spindles	19
Approx. Weight	4880kg
Min Tractor HP	100hp

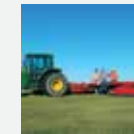

Trimax X-WAM is great equipment. It replaced one tractor, one employee and reduced mowing time. Less equipment to maintain and less equipment expense has increased our profitability.

- LYNN GIBB | Hope Plantation Turf, Texas USA

→ FEATURES



LOCTEK

A stubless roller bearing system for vastly improved roller retention, alignment, bearing life and minimal maintenance.



FULL HYDRAULIC OPERATION

The X-WAM uses full hydraulic operation for deck retraction into road transport mode.



LAZERBLADEZ™

Available in up-lift and flat formation to suit mowing requirements, the unique tilt forward design minimises hang back in tough conditions.



STEADFAST SEALED SPINDLES

We've eliminated the tedious task of regular greasing. Covered by our 3-year warranty, maintenance costs are reduced, and productivity is enhanced.



TURF TYRE

Trimax Turf Tyres help distribute the weight of the mower for less ground disturbance. Recommended for Turf Farms or fine turf applications.



LOW MAINTENANCE

All moving surfaces have long life synthetic bushes or greasable bearings and remote grease points for hassle-free maintenance.



ULTIMATE CONTOUR FOLLOWING

Contour following and cut quality is compromised when decks are over 3m wide. The X-WAM features multiple smaller decks for superior cut quality.



RAPIDSET HEIGHT ADJUSTMENT

Clearly displayed stainless steel height indicators allow the easy adjustment of cut heights without having to raise or lower the wings.



WHEELS RUN ON CUT GRASS

As the rear deck is located between the rear transport wheels, grass is not flattened by wheels prior to mowing, a feature unique to Trimax.

*OPTIONAL FEATURES

- ✓ QUATTRO BLADE SYSTEM
- ✓ HELICAL ROLLER SCRAPERS
- ✓ ANTI-BOUNCE SKIDS
- ✓ GALVANIZED SURFACE COATING

For full description of Options go to Page 39 →





FLAIL MOWERS

We build exceptional front and rear mount flail mowers that produce the best cut possible whilst ensuring you spend less time and money on maintenance.



FLAILDEK // FX

The Trimax FLAILDEK FX offers a high-performance alternative to standard factory-fitted rotary mowing attachments.

FlailDek FX has the ability to deliver an exceptionally clean cut and disperse clippings safely and is used by contractors, councils, schools and land owners around the world. A highly versatile mower, FlailDek FX is also able to mulch branches up to 25mm in diameter, mow high grass and using the unique converter flap is suitable for sports fields and other fine turf applications.

The FlailDek FX has been designed to have minimal maintenance requirements and a low total cost of ownership yet deliver maximum reliability.

Talk to us today about the capabilities of FlailDek FX in your environment.

TRIMAX FLAIL
TECHNOLOGY FOR OUT
FRONT OPERATION.



FITMENT

A front mounted flail mower that can be fitted to a wide range of tractors including John Deere, Kubota, Iseki, New Holland and Shibaura out-front tractors. FlailDek FX is supplied complete with mounting arms and PTOs to suit the brand of tractor. Minimum hp recommendations vary between tractor brands.

DESIGN AND CONSTRUCTION

The FlailDek FX has a low compact design which mounts close to the tractor. Mounted by linkage arm adapters and quick hitch using one pin, the mower floats independently and lifts high for kerb clearance. The front of the body aperture is very open and is fitted with a row of hinged safety flaps which fold back to allow standing vegetation easy entry yet contain any thrown objects. Roller bearings are encased in protective housings. The FlailDek uses a monocoque body construction made from 3mm high tensile plate steel.

✓ THE CONVERTER™ FEATURE

The Converter™ feature is unique to Trimax and changes a versatile "jack-of-all trades" flail mower into a machine that is a master of widely differing conditions. In the short grass configuration it excels when mowing quality turf, lifting each blade to eliminate wheel marks. Move the Converter and the same machine transforms metre-high grass and stalky weeds into lawn in a single pass.

APPLICATIONS

- ✓ Municipality
- ✓ Horticulture
- ✓ Turf Farm
- ✓ Golf
- ✓ Racecourse
- ✓ School
- ✓ Lifestyle
- ✓ Sports Field
- ✓ Aviation

➔ FEATURES



UNIQUE CONVERTER

Superb short grass cutting ability by creating airflow that lifts grass before it's cut. For work in heavy environments lift converter for increased productivity.



SAFE CLIPPING DISPERSION

Safety is paramount when mowing in public areas. This is why Trimax has designed the FlailDek FX to expel debris in a downward direction behind the mower.



REAR ROLLER

Full width rear roller prevents scalping, permits the edge of the mower to be run along kerbs, adds to overall safety and produces striping.



FRONT CASTOR WHEELS

Front castor wheels allow the FlailDek FX to follow ground contours independently from the tractor. The semi-pneumatic tires are impossible to puncture.



POWER SAVING FLAILS

Strong forged steel flail with an aerodynamic profile reduces hp requirements yet generates sufficient draught to lift grass for a clean cut.



NEW IMPROVED ROTOR

Designed to withstand the toughest environments our new rotor is more durable ensuring downtime is kept to an absolute minimum.



WEAR RESISTANT SKIDS

Wear resistant trailing skids made from abrasion-resistant steel extends bearing life and enables high productivity in the most challenging environments.



SPECIFICATIONS	135	155	185
Cutting Width	1360mm (54")	1520mm (60")	1830mm (72")
Overall Width	1560mm (61")	1720mm (68")	2045mm (81")
Overall Length	1095mm (43")	1095mm (43")	1095mm (43")
Cut Height Range	20 - 100mm (¾" - 4")	20 - 100mm (¾" - 4")	20 - 100mm (¾" - 4")
Approx. Weight	236kg	242kg	280kg
Total Belts	2	2	2
Min PTO Output	Front mount HP's vary between tractor brands.		



This year I could not have coped without anything other than a Trimax FlailDek, it's versatile, cuts rough and fine grass even in the wet conditions and copes with it easily.

- ANDREW HALL | Truelink Ltd





TRIMAX FLAIL
TECHNOLOGY FOR
COMPACT TRACTORS.

EZEEMOW//FX

The new EZEEMOW FX is the ideal partner for your compact tractor where versatility and robustness is needed.

With its compact dimension Ezeemow FX can fit closely to the tractor and manoeuvre into tight corners. Able to mow anything from fine turf to small prunings, vegetation up to 25mm in diameter and high grass, the Ezeemow FX can transform areas into tidy mown lawn in a single pass. This versatility makes the Ezeemow FX ideal for contractors, councils, roadsides, estates, and orchard applications.

The Ezeemow FX has been designed to have minimal maintenance requirements and low total cost of ownership yet deliver maximum reliability.

Talk to us today about the capabilities of Ezeemow FX in your environment.



FITMENT

Rear 3-point linkage mounted compact flail mower suitable for tractors with a minimum of 17-24hp.

DESIGN AND CONSTRUCTION

The Ezeemow FX has a low and compact design which mounts close to the tractor. The front of the body aperture is very open and is fitted with a row of hinged safety flaps which fold back to allow standing vegetation easy entry yet contain any thrown objects. The Ezeemow uses a monocoque body construction made from 3mm high tensile plate steel.

IMPROVEMENTS OVER THE ORIGINAL EZEEMOW

Ezeemow FX is a total re-design of the original Ezeemow with a change in construction to a high tensile steel, a larger diameter rotor (70% stronger) and forged steel Gamma Flails™. A stronger gearbox has been used and an improved belt tensioning system. The full width rear roller is now easily height adjustable.

APPLICATIONS

✓ Municipality ✓ Horticulture ✓ Horse Agistment



SPECIFICATIONS	135	155	185
Cutting Width	1360mm (54")	1520mm (60")	1830mm (72")
Overall Width	1560mm (61")	1720mm (68")	2045mm (81")
Overall Length	583mm (23")	583mm (23")	583mm (23")
Cut Height Range	10 - 100mm ($\frac{3}{8}$ " - 4")	10 - 100mm ($\frac{3}{8}$ " - 4")	10 - 100mm ($\frac{3}{8}$ " - 4")
Approx. Weight	198kg	228kg	245kg
Total Belts	2	2	2
Min Tractor HP	17hp	20hp	24hp



FEATURES



POWER SAVING FLAILS

Strong forged steel flail with an aerodynamic profile reduces hp requirements yet generates sufficient draught to lift grass for a clean cut.



REAR ROLLER

Full width rear roller prevents scalping, permits the edge of the mower to be run along kerbs, adds to overall safety and produces striping.



NEW IMPROVED ROTOR

Designed to withstand the toughest environments our new rotor is more durable ensuring downtime is kept to an absolute minimum.

*OPTIONAL FEATURES

✓ CONVERTER FLAP

For full description of Options go to Page 39 →



SAFE CLIPPING DISPERSION

Safety is paramount when mowing in public areas. This is why Trimax has designed the Ezeemow FX to expel debris in a downward direction behind the mower.



*OFFSET OR CENTRE MOUNT OPTIONS

Available in offset or centre mount to suit your mowing requirements



I've been mowing 30hrs a week for over 28 years and my Ezeemow still has the same gearbox. It produces a beautiful cut and if I had to, I'd replace it with the exact same model...no two ways about it!

- STEVE DE BRUIN | Grass Cutting Services, Tauranga NZ



WARLORD//S3

The all new WARLORD S3 with its hydraulic sideshift operation makes for a powerful working companion in agricultural and horticultural applications.

We've designed the Warlord Series 3 to be a safe and reliable machine and have maintained our robust build which makes the Warlord the flail mower of choice. With the ability to shred branches up to 75mm in diameter the Warlord will turn shelter belt trimmings and orchard offcuts into the finest mulch. Fitted with unique features such as a replaceable internal liner, pruning guide and an adjustable rear flap for servicing ease and the added ability of moving the mower around trees and obstacles, the Warlord is a serious agricultural and horticultural flail mower.

Talk to us today about the capabilities of Warlord Series 3 in your environment.



HEAVY DUTY FLAIL
MULCHER MOWER.

FITMENT

Rear 3-point linkage tractor mounted flail mower to suitable for tractors with a minimum of 50hp.

DESIGN AND CONSTRUCTION

Warlord has a dynamically balanced rotor constructed from 11mm seamless wall tube. Hinged front safety flaps allow a large volume of material into the cutting chamber and prevent material being thrown forward. The Warlord features an easily adjusted four-belt drive to the rotor using SPBX belts.

The Warlord has a monocoque body construction made from 6mm plate steel. Warlord comes right hand offset as standard unless specified otherwise.

APPLICATIONS

✓ Horticulture ✓ Turf Farm ✓ Golf ✓ Racecourse ✓ School ✓ Lifestyle ✓ Sports Field ✓ Aviation



Three things make the Warlord special; the adjustable rear discharge flap, the forged Gamma flails and the after-market support. A two-minute adjustment of the rear discharge flap fine-tunes the machine for normal mowing, shredding prunings into the finest mulch, for cutting extremely long grass, or just for providing excellent access to the rotor for maintenance. The multi-purpose Gamma flails provide the best quality grass cutting and, by taking small bites, eat up the largest prunings. These features are supported by readily available spare parts and technical help from an experienced team. It's a robust and reliable multi-purpose machine!

- JIM MCEWEN | Senior Innovation Advisor of Trimax Mowing Systems

SPECIFICATIONS	175	205	235
Cutting Width	1740mm (69")	2040mm (80")	2340mm (92")
Overall Width	2036mm (80")	2336mm (92")	2636mm (104")
Overall Length	1050mm (41")	1050mm (41")	1050mm (41")
Cut Height Range	0 - 70mm (0 - 2¾")	0 - 70mm (0 - 2¾")	0 - 70mm (0 - 2¾")
Approx. Weight	674kg	752kg	789kg
Total Belts	4	4	4
Min Tractor HP	50hp	60hp	70hp
Flails per mower	24	28	32
Rollers	1	1	1

→ FEATURES



HYDRAULIC SIDE SHIFT

The Warlord can be quickly offset to the left or right by up to 500mm. Perfect for transport and manoeuvring around obstacles whilst mowing.



DISCHARGE CONTROL

Fine mulch is produced with the flap in the lowest position. Controlling discharge assists with safety in public spaces. Lift flap open for easy flail servicing.



PRUNING GUIDE

Helps direct prunings in and under the mower. Also helps keep debris away from the hydraulic system.



REPLACEABLE INTERNAL LINER

A bolt-in 6mm replaceable internal liner increases the life of the body, minimises damage and reduces noise.

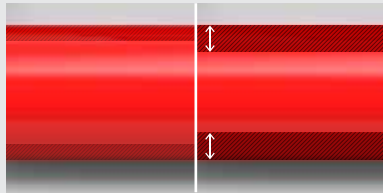

ROADSIDE ROLLER

A replaceable 11mm heavy duty roller for demanding applications such as roadsides. Roller height can be easily adjusted.



*LEFT-HAND OFFSET

Suitable for roadside mowing contractors. When visibility over the left hand shoulder is preferred. See offset graphs on page 38.



*OPTIONAL FEATURES

- ✓ ROADSIDE SKIDS
- ✓ ROADSIDE ROLLER

For full description of Options go to Page 39 →



WARLORD S3

Hydraulic Side Shift

RIGHT HAND
OFFSETS
AVAILABLE

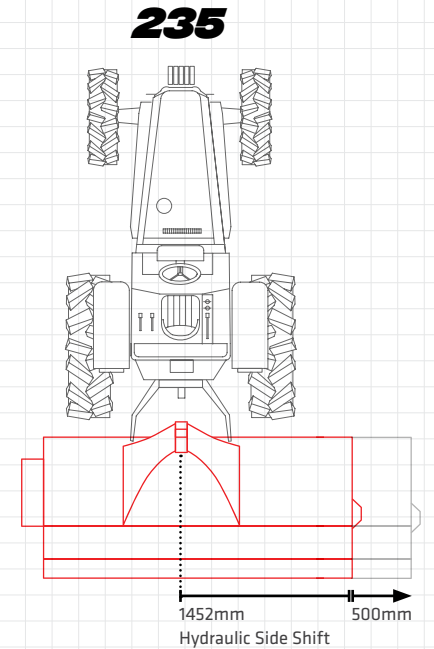
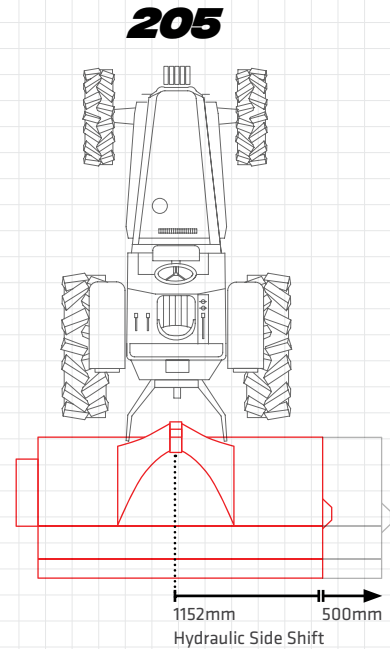
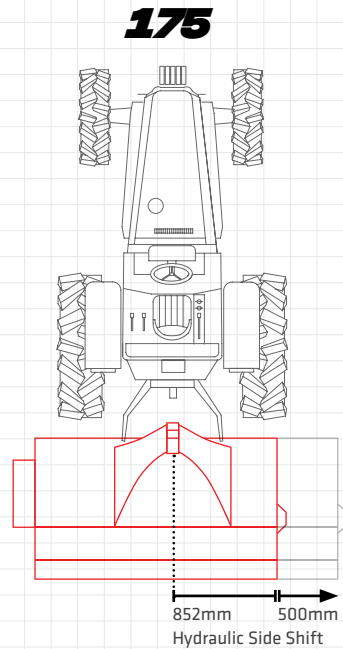

EZEEMOW FX

Please note Ezeemow is only available in fixed centre mount or offset positions.

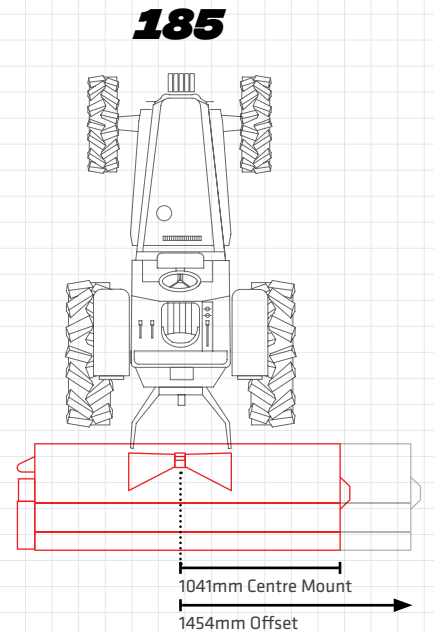
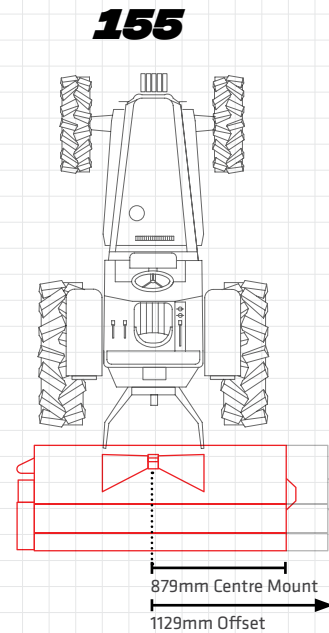
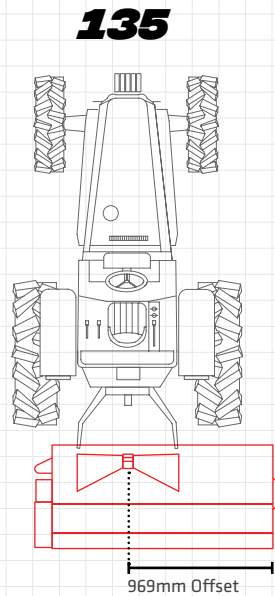

Common Product Options.



← QUATTRO BLADES

Adds two more blades to each spindle for a total of four. Creates greater vacuum, more cuts per forward metre of travel and a finer cut. Different combinations available (flat, upturned or mixture).



← ELECTRIC BRAKES

Reduces the braking force needed from the tractor. Includes adjustable brake controller with proportional boost and lockout switch so brakes can be deactivated while mowing.



← ROAD KIT

The road kit option adds mudguards to wheels and includes LED tail light clusters.



← HELICAL ROLLER SCRAPERS

Trimax helical roller scrapers apply constant pressure on the mower rollers keeping them clean and free of clippings and reduces grass clumping in wet conditions.



← STORAGE AND LIGHTING KIT

Includes storage toolbox, mounting bracket, LED road lights and safety triangle for commercial use.



← UNIQUE CONVERTER

Open unique converter for long grass entry and close for fine grass mowing.



← QUIKLIFT

Enables mower decks to be raised slightly to traverse paths without disengaging the PTO. Protects cool season grass from damage when turning and allows effective striping of turf.



← REMOTE UNLOCK

Allows the electric unlock of decks by pushing a button from inside the tractor cab. Replaces the standard transport lock release rope.



← SPARE TYRE KIT

Easy and convenient mounting kit for spare tyre.



← ANTI-BOUNCE SKIDS

Reduces wear on side channels when operating in harsh terrain, also eliminates 'scalping' when mowing on uneven turf and stops mower decks from bouncing when mowing at high speeds.

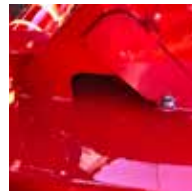

← DUAL WASH PORTS

Provides easy access for the removal of grass and drainage of water from the belt cavity while cleaning.

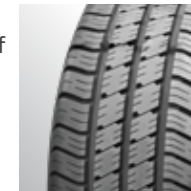

← ROAD RATED TYRE

Add a road rated tyre for the ability to tow at speeds greater than 40km/ph on the road.



← ROADSIDE SKIDS

Replaceable skids reduce wear on side channels when operating in rough or uneven terrain.



← GALVANIZED SURFACE COATING

Provides added protection against corrosion in coastal environments with high salt concentrations or high fertiliser usage.

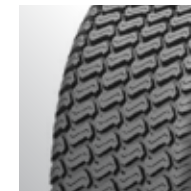

← TURF TYRES

Trimax Turf Tyres help distribute the weight of the mower for less ground disturbance. Recommended for Turf Farms or fine turf applications.



← INDIVIDUAL LIFT SYSTEM

The Individual Lift System allows independent lift of either side deck for reduced cutting in confined spaces



← FRONT MOUNT

Front mount provides visual convenience for operators that prefer out front operation. Suitable for tractors that have out front PTO drives only.



← SERVICE STANDS

Lockable stands which hold the mower up safely to assist with service and maintenance.



 **trimax**™ // **POWERING PERFORMANCE.**
MOWING SYSTEMS

70 Malerne Street, 3112 Tauranga, NZ // SALES +64 7 543 1892 // PARTS +64 7 543 1897 // info@trimaxmowers.co.nz

 // **TRIMAXMOWERS.CO.NZ**

Your nearest authorised dealer:

