



POWERING PERFORMANCE.

PRODUCT CATALOGUE.

★★★
INDUSTRY LEADING WARRANTY

3
YEAR

INCLUDES SPINDLES & GEARBOXES

EXPERIENCED SERVICE & SUPPORT NETWORK

* T & Cs APPLY



**EQUIPMENT THAT
POWERS
PERFORMANCE.**

From humble beginnings in New Zealand, to a world leader in Commercial Mowing - our success is driven by a passion to help customers find a better way.

We listen to how you use our products, designing with customer focused innovation to solve problems you encounter. The result? Mowing solutions which increase productivity, reduce maintenance and can be relied on day-after-day, for years of full time commercial use.



**LONG
COMMERCIAL LIFE.**



**LOW TOTAL-COST-
OF-OWNERSHIP.**



**EASE OF
MAINTENANCE.**



**INTUITIVE
TO USE.**



**INDUSTRY LEADING
CUT PRESENTATION.**



**SERVICE THAT EXCEEDS
EXPECTATIONS.**

**EQUIPMENT
SHOULD NEVER
BE A BARRIER TO
SUCCESS.**

- BOB SIEVWRIGHT / FOUNDER & OWNER

Founded in the Bay of Plenty, New Zealand in 1981, Trimax has grown from a modest workshop into a global business with facilities around the world. Our global headquarters - and much of our manufacturing - still resides where we started in Tauranga, New Zealand.

We are renowned for designing and manufacturing mowing systems which produce a high-quality cut, finish, and spread - but what we value most is the reputation we have earned for providing unmatched local support and service.





OUR APPROACH TO INNOVATION IS DRIVEN BY YOU. WITH A FOCUS ON CREATING SOLUTIONS TO YOUR CHALLENGES, TOGETHER, WE'RE ABLE TO RAISE THE BAR ON RESULTS.



- BOB SIEVWRIGHT
TRIMAX MOWING SYSTEMS
OWNER/FOUNDER



- MICHAEL SIEVWRIGHT
TRIMAX MOWING SYSTEMS
CEO



ROTARY MOWERS.

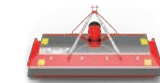

STRIKER



PROCUT/S5



PROCUT/S5 SR



PROCUT/S5 FM



TOPPER/S3



FURY



STEALTH/S3



STEALTH/S3 SR



SNAKE/S3



PEGASUS/S5



PEGASUS/S5 SR



X-WAM

FLAIL MOWERS.



FLAILDEK/FX



EZEEMOW/FX



FORCE



WARLORD/S3

TRIMAX STRIKER

FAST BECOMING THE MOWER OF CHOICE AMONGST GROUNDSMEN.

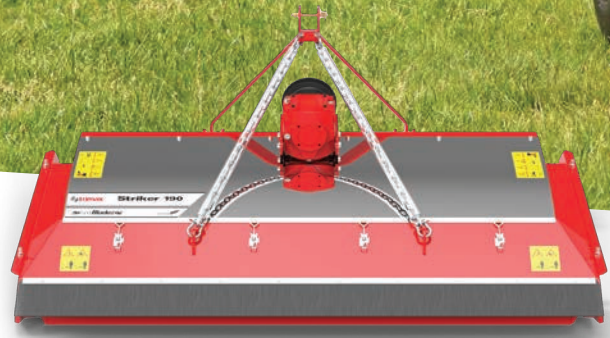

TRIMAX STRIKER

Trimax STRIKER is a multi-spindled rotary mower with extremely low maintenance requirements and is ideal for use on compact tractors.

The Trimax Striker is designed to give a high cut quality and an excellent spread of clippings. Highly versatile, the Striker is capable of mowing grass 10 to 100mm. With an enclosed cutting chamber and a downward rear dispersion of clippings, the Striker has surpassed international safety standards making it one of the safest mowers on the market for use in public spaces.

Fitted with Trimax's exclusive LazerBladez™, the Striker can produce a cut and finish to rival that of a cylinder mower and is ideal for educational and sports facilities where presentation is key!

TALK TO US TODAY ABOUT THE CAPABILITIES OF STRIKER IN YOUR ENVIRONMENT.



SPECIFICATIONS	150	190
Cutting Width	1.46m (4' 9 1/2")	1.94m (6' 4 1/2")
Overall Width	1.56m (5' 1 1/2")	2.04m (6' 8 1/2")
Overall Length	1.16m (3' 9 1/2")	1.16m (3' 9 1/2")
Height	0.83m (2' 8 1/2")	0.83m (2' 8 1/2")
Cut Height Range	10 - 100mm (3/8" - 4")	10 - 100mm (3/8" - 4")
No. of Blade Spindles	3	4
Approx. Weight	322kg (710lbs)	400kg (882lbs)
Min PTO Output	25hp	30hp

*Minimum PTO output is a guide only. Requirement varies with the type of work and the terrain



The Striker has been built to withstand all conditions, a good solid mower. We had a test mow on delivery, the grass was about 150mm high and wet, it went great, made a good even cut leaving an even spread of cut grass, we thought it was the best mower we had ever seen.

- IAN DUFTY Morrinsville, NZ

KEY APPLICATIONS.

✓ School & Sports Fields ✓ Golf & Country Club ✓ Lifestyle & Estates

WHAT'S NEW ON STRIKER

The Striker was originally designed as a compact solution for sports turf, especially for grounds maintenance for local football and cricket clubs. It features a simpler pan construction than the ProCut and includes maintenance-free ball bearing spindles.

INDUSTRY LEADING WARRANTY

3 YEAR

INCLUDES SPINDLES & GEARBOXES
EXPERIENCED SERVICE & SUPPORT NETWORK



PRODUCT FEATURES.



LOW COST OF OWNERSHIP
With only 4 grease points on the mower and with robust sealed spindles, the Trimax Striker has incredibly low maintenance requirements.



LAZERBLADEZ™
Available in uplift and flat formation to suit mowing requirements, the unique tilt forward design minimises hang back in tough conditions.



STRIPING CAPABLE
Fitted with full width front and rear rollers, the Striker can produce striped patterned turf for those spaces where presentation is key.



SAFETY FOR PUBLIC PLACES
Striker exceeds international safety standards, and can be used with confidence in public spaces, school sports fields and confined



ADVANCED ENGINEERING
Trimax's meticulous design process combined with bespoke, innovative manufacturing technologies produce the most accurate rotary



COMPACT TRACTOR SUITABLE
Able to be paired with tractors as low as 25hp, the Striker is perfect for smaller budgets and compact tractors.

*OPTIONAL FEATURES.

- ✓ **ROLLER SCRAPERS**
Cleans rollers and reduces clumping in wet conditions.
- ✓ **NEXABLADES**
Scientifically designed for high-end turf giving a superior cut and spread when it matters most.

VIEW MORE PHOTOS, VIDEOS, AND INFORMATION ABOUT THE TRIMAX STRIKER ONLINE HERE:



TRIMAX PROCUT/S5



**ENGINEERED TO WITHSTAND
EVERYDAY USE IN THE
TOUGHEST COMMERCIAL
ENVIRONMENTS.**



TRIMAX PROCUT/S5

A highly versatile roller mower, the PROCUT SERIES 5 is a multi-spindled roller mower designed to give a high cut quality and a great spread of clippings.

The ProCut has been a successful part of the Trimax range for over 30 years. Mowing parks, reserves, school grounds, sports fields and golf courses around the world - From the grounds of Windsor Castle to your local community sports fields.

The ProCut Series 5, released in 2023 is excellence refined. The ProCut S5 builds on the market leading cut and spread quality of the previous series whilst removing all daily maintenance requirements making it the perfect solution for a variety of commercial environments.

**TALK TO US TODAY ABOUT THE
CAPABILITIES OF PROCUT SERIES 5
IN YOUR ENVIRONMENT.**



SPECIFICATIONS	178	210	237	290
Cutting Width	1.74m (5' 8 1/2")	2.06m (6' 9")	2.32m (7' 7")	2.89m (9' 6")
Overall Width	1.89m (6' 2 1/2")	2.21m (7' 3")	2.47m (8' 1")	3.04m (10')
Overall Length	1.44m (4' 9")	1.51m (4' 11 1/2")	1.44m (4' 9")	1.44m (4' 9")
Height	1.08m (3' 6 1/2")	1.08m (3' 6 1/2")	1.08m (3' 6 1/2")	1.08m (3' 6 1/2")
Cut Height Range	10 - 110mm (3/8" - 4 1/3")	10 - 110mm (3/8" - 4 1/3")	10 - 110mm (3/8" - 4 1/3")	10 - 110mm (3/8" - 4 1/3")
No. of Blade Spindles	3	3	4	5
Approx. Weight	492kg (1085lbs)	543kg (1197lbs)	605kg (1334lbs)	707kg (1559lbs)
Min PTO Output	35hp	40hp	45hp	55hp



The ProCut is a great mower. I mow 19 schools at 40mm and the schools always comment on how nice the grounds look. I mow fast and the spread is great. I'd recommend Trimax to anyone!

- ALLEN COE | Schools Contractor, NZ

KEY APPLICATIONS.

✓ Municipal & Contractors ✓ School & Sports Fields ✓ Turf ✓ Golf & Country Clubs ✓ Lifestyle & Estates

WHAT'S NEW ON PROCUT S5

Maintaining your mower has never been easier with all daily greasing requirements being removed with the implementation of the new Titan Roller Bearings. The new auto-belt tensioning system reduces belt maintenance and improves drive to the spindles for a cleaner, more consistent cut in heavy conditions.

INDUSTRY LEADING WARRANTY

3 YEAR INCLUDES SPINDLES & GEARBOXES
EXPERIENCED SERVICE & SUPPORT NETWORK

PRODUCT FEATURES.



TITAN ROLLER BEARING SYSTEM
The Trimax Titan roller bearing system is maintenance-free, requiring no regular greasing, and provides excellent retention.



AUTOMATIC BELT TENSIONING
Removes the need for belt adjustments and improves drive to the spindles and blades.



LAZERBLADEZ™
Available in uplift and flat formation to suit mowing requirements, the unique tilt forward design minimises hang back in tough conditions.



LOW MAINTENANCE
Zero daily maintenance. Spindles, roller bearings and auto-belt tensioning are maintenance-free.



STEAFAST SEALED SPINDLES
We've eliminated the tedious task of regular greasing. Covered by our 3-year warranty, maintenance costs are reduced, and productivity is enhanced.



BELT CAVITY DUAL WASH FLAPS
Provides easy access for removal of grass and drainage of water from belt chamber.



PRECISE HEIGHT ADJUSTMENT
Clearly displayed indicators in both metric and imperial units and a high-tensile 2mm pitch adjuster for precise cut height alterations.

*OPTIONAL FEATURES.

✓ **ANTI-BOUNCE / WEAR SKIDS**
Eliminates scalping and bouncing and reduces side channel wear.

✓ **ROLLER SCRAPERS**
Cleans rollers and reduces clumping in wet conditions.

✓ **LIGHTING KIT WITH STORAGE BRACKET**
LED road lights, safety triangle, and bracket for storage box.

✓ **STORAGE BOX**
Easy access to spare parts and tools.

✓ **FRONT MOUNT**
Convenient visibility. Only for tractors with front PTO drive.

✓ **SINGLE ROLLER**
Allows greater grass intake at the front of the mower.

✓ **GALVANIZED SURFACE COATING**
Protect against corrosion in harsh environments.

✓ **QUATTRO BLADES**
Four blades (flat, upturned or mixed) per spindle for a finer cut.

✓ **NEXABLADES**
Scientifically designed for high-end turf giving a superior cut and spread when it matters most.

✓ **ON CALL KIT**
Each kit contains bearings blades and belts for a quick replacement in the field.

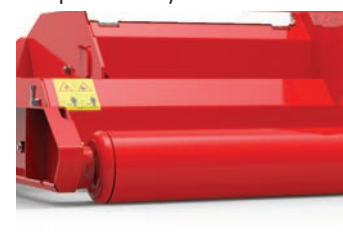

FULL WIDTH ROLLERS
Full width rollers minimise scalping in undulating conditions and allow mowing over kerbsides and bunkers. Also aids in striping.



ACCURATE SPINDLE SETTING TECHNOLOGY
Spindle height is perfectly aligned providing the most accurate cut possible.



STAND ON COVERS
Enables safe and easy access to the rear of the tractor when coupling the mower. Quick release latches allow easy removal for cleaning and servicing.

**VIEW MORE PHOTOS, VIDEOS, AND INFORMATION
ABOUT THE TRIMAX PROCUT SERIES 5 ONLINE HERE:**



TRIMAX PROCUT/S5 SR



**ENGINEERED TO TACKLE
LONG GRASS APPLICATIONS IN
THE TOUGHEST COMMERCIAL
ENVIRONMENTS.**

TRIMAX PROCUT/S5 SR

The original ProCut found phenomenal success in long grass applications due to its rigid construction, cut quality and manoeuvrability. With the ProCut S5 we have taken this to another level.

The Single Roller ProCut S5 is a long grass mower that provides a market leading cut and finish. Engineered with a low body profile and increased under deck clearance it provides excellent clipping distribution without any daily maintenance requirements.

Built with industry leading strength and durability, this is the machine you need for any commercial long grass applications.

TALK TO US TODAY ABOUT THE CAPABILITIES OF PROCUT SERIES 5 SR IN YOUR ENVIRONMENT.

SPECIFICATIONS	178	210	237	290
Cutting Width	1.74m (5' 8 1/2")	2.06m (6' 9")	2.32m (7' 7")	2.89m (9' 6")
Overall Width	1.91m (6' 3")	2.22m (7' 3 1/2")	2.48m (8' 1 1/2")	3.05m (10' 1/2")
Overall Length	1.36m (4' 5")	1.43m (4' 8")	1.36m (4' 5")	1.36m (4' 5")
Height	1.08m (3' 6 1/2")	1.08m (3' 6 1/2")	1.08m (3' 6 1/2")	1.08m (3' 6 1/2")
Cut Height Range	10 - 110mm (3/8" - 4 1/3")	10 - 110mm (3/8" - 4 1/3")	10 - 110mm (3/8" - 4 1/3")	10 - 110mm (3/8" - 4 1/3")
No. of Blade Spindles	3	3	4	5
Approx. Weight	462kg (1019lbs)	509kg (1122lbs)	568kg (1252lbs)	663kg (1462lbs)
Min PTO Output	35hp	40hp	45hp	55hp

**Minimum PTO output is a guide only. Requirement varies with the type of work and the terrain*



The ProCut is over and above what we ever expected. We knew we needed more than just a slasher, the fine cut and even dispersion of the ProCut leaves a fantastic presentation.

- DALE COOK | Copelands Estate, Warragul, VIC, AUSTRALIA

KEY APPLICATIONS.

✓ Horticulture ✓ Municipal & Contractors ✓ Aviation ✓ Racecourses ✓ Lifestyle & Estates

WHAT'S NEW ON PROCUT S5 SR

Maintaining your mower has never been easier with all daily greasing requirements being removed with the implementation of the new Titan Roller Bearings. The new auto-belt tensioning system reduces belt maintenance and improves drive to the spindles for a cleaner, more consistent cut in heavy conditions.



PRODUCT FEATURES.



TITAN ROLLER BEARING SYSTEM
The Trimax Titan roller bearing system is maintenance-free, requiring no regular greasing, and provides excellent retention.



AUTOMATIC BELT TENSIONING
Removes the need for belt adjustments and improves drive to the spindles and blades.



LAZERBLADEZ™
Available in uplift and flat formation to suit mowing requirements, the unique tilt forward design minimises hang back in tough conditions.



LOW MAINTENANCE
Zero daily maintenance. Spindles, roller bearings and auto-belt tensioning are maintenance-free.



STEAFAST SEALED SPINDLES
We've eliminated the tedious task of regular greasing. Covered by our 3-year warranty, maintenance costs are reduced, and productivity is enhanced.



BELT CAVITY DUAL WASH FLAPS
Provides easy access for removal of grass and drainage of water from belt chamber.



PRECISE HEIGHT ADJUSTMENT
Clearly displayed indicators in both metric and imperial units and a high-tensile 2mm pitch adjuster for precise cut height alterations.

*OPTIONAL FEATURES.

- ✓ **REAR ROLLER SCRAPER**
Cleans rollers and reduces clumping in wet conditions.
- ✓ **STORAGE & LIGHTING KIT**
Mounts toolbox, LED road lights and safety triangle to mower.
- ✓ **GALVANIZED SURFACE COATING**
Protect against corrosion in harsh environments.
- ✓ **ON CALL KIT**
Each kit contains bearings blades and belts for a quick replacement in the field.
- ✓ **STORAGE BOX**
Easy access to spare parts and tools.

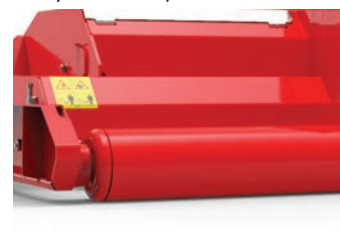

FULL WIDTH ROLLER
Full width roller minimises scalping in undulating conditions and aids in striping.



ACCURATE SPINDLE SETTING TECHNOLOGY
Spindle height is perfectly aligned providing the most accurate cut possible.



STAND ON COVERS
Enables safe and easy access to the rear of the tractor when coupling the mower. Quick release latches allow easy removal for cleaning and servicing.

VIEW MORE PHOTOS, VIDEOS, AND INFORMATION ABOUT THE TRIMAX PROCUT SR ONLINE HERE:



TRIMAX PROCUT/S5 FM



TAKES A Paddock TO HIGH LEVELS OF PRESENTATION.



TRIMAX PROCUT/S5 FM

The front mounted version of the ever-popular rear linkage mounted Trimax PROCUT.

The Trimax ProCut FM is a robust machine engineered to withstand everyday use in the toughest commercial environments yet will deliver a clean cut – every time. In operation, the front-mounted ProCut Series 5 rides on the ground on its front wheels and rear roller. The front castor wheels and rear roller follow ground contours allowing easy manoeuvrability and prevent scalping. With out-front mowing the need for the operator to look behind is reduced and the tractor wheels do not flatten the uncut grass.

TALK TO US TODAY ABOUT THE CAPABILITIES OF PROCUT SERIES 5 FM IN YOUR ENVIRONMENT.



SPECIFICATIONS	178	210	237	290
Cutting Width	1.74m (5' 8 1/2")	2.06m (6' 9")	2.32m (7' 7")	2.89m (9' 6")
Overall Width	1.91m (6' 3")	2.22m (7' 3 1/2")	2.48m (8' 1 1/2")	3.05m (10' 1 1/2")
Overall Length	1.65m (5' 5")	1.72m (5' 8")	1.65m (5' 5")	1.65m (5' 1/2")
Height	1.08m (3' 6 1/2")	1.08m (3' 6 1/2")	1.08m (3' 6 1/2")	1.08m (3' 6 1/2")
Cut Height Range	10 - 110mm (3/8" - 4 1/8")	10 - 110mm (3/8" - 4 1/8")	10 - 110mm (3/8" - 4 1/8")	10 - 110mm (3/8" - 4 1/8")
No. of Blade Spindles	3	3	4	5
Approx. Weight	569kg (1254lbs)	616kg (1358lbs)	675kg (1488lbs)	770kg (1697lbs)
Min PTO Output	35hp	40hp	45hp	55hp

**Minimum PTO output is a guide only. Requirement varies with the type of work and the terrain*

KEY APPLICATIONS.

- ✓ Municipal & Contractors
- ✓ School & Sport Fields
- ✓ Golf & Country Clubs
- ✓ Horticulture
- ✓ Aviation
- ✓ Racecourses

WHAT'S NEW ON PROCUT/S5 FM

Maintaining your mower has never been easier with all daily greasing requirements being removed with the implementation of the new Titan Roller Bearings. The new auto-belt tensioning system reduces belt maintenance and improves drive to the spindles for a cleaner, more consistent cut in heavy conditions.

INDUSTRY LEADING WARRANTY

3 YEAR INCLUDES SPINDLES & GEARBOXES
EXPERIENCED SERVICE & SUPPORT NETWORK

PRODUCT FEATURES.



TITAN ROLLER BEARING SYSTEM
The Trimax Titan roller bearing system is maintenance-free, requiring no regular greasing, and provides excellent retention.



AUTOMATIC BELT TENSIONING
Removes the need for belt adjustments and improves drive to the spindles and blades.



LAZERBLADEZ™
Available in uplift and flat formation to suit mowing requirements, the unique tilt forward design minimises hang back in tough conditions.



LOW MAINTENANCE
Zero daily maintenance. Spindles, roller bearings and auto-belt tensioning are maintenance-free.



STEADFAST SEALED SPINDLES
We've eliminated the tedious task of regular greasing. Covered by our 3-year warranty, maintenance costs are reduced, and productivity is enhanced.



BELT CAVITY DUAL WASH FLAPS
Provides easy access for removal of grass and drainage of water from belt chamber.



PRECISE HEIGHT ADJUSTMENT
Clearly displayed indicators in both metric and imperial units and a high-tensile 2mm pitch adjuster for precise cut height alterations.

*OPTIONAL FEATURES.

- ✓ **REAR MOUNT**
Available in rear three-point linkage configuration with front and rear rollers for unmatched safety.
- ✓ **ROLLER SCRAPERS**
Cleans rollers and reduces clumping in wet conditions.
- ✓ **QUATTRO BLADES**
Four blades (flat, upturned or mixed) per spindle for a finer cut.
- ✓ **NEXABLADES**
Scientifically designed for high-end turf giving a superior cut and spread when it matters most.
- ✓ **ON CALL KIT**
Each kit contains bearings blades and belts for a quick replacement in the field.

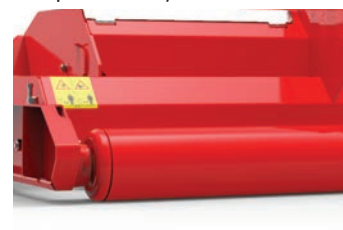

FULL WIDTH ROLLER
Full width roller minimises scalping in undulating conditions and aids in striping.



ACCURATE SPINDLE SETTING TECHNOLOGY
Spindle height is perfectly aligned providing the most accurate cut possible.



STAND ON COVERS
Enables safe and easy access to the rear of the tractor when coupling the mower. Quick release latches allow easy removal for cleaning and servicing.

VIEW MORE PHOTOS, VIDEOS, AND INFORMATION ABOUT THE TRIMAX PROCUT FM ONLINE HERE:



TRIMAX TOPPER/S3



TRIMAX TOPPER/S3

The Trimax TOPPER cuts pasture quickly and efficiently and has multiple features enabling its use on lower hp tractors.

Developed on a Waikato dairy farm in 1993, the Topper uses small diameter blades turning at high speed resulting in more cuts per forward metre than comparable pasture toppers, giving a finer cut and increasing regrowth and pasture quality. The high under-body clearance and open deck design allows good flow of grass into the mowing deck and a clean ejection of cut grass.

Powered by a proven belt drive system that now has auto belt tensioners, the Trimax Topper is more efficient than comparable shaft drive pasture toppers. Short in body from front to rear and mounting close to the tractor, the Topper is able to be used on smaller tractors for large cut widths and also enables a smaller turning radius for easier access into tight corners.

TALK TO US TODAY ABOUT THE CAPABILITIES OF TOPPER SERIES 3 IN YOUR ENVIRONMENT.



SPECIFICATIONS	237	282
Cutting Width	2.32m	2.74m
Overall Width	2.48m	2.91m
Overall Length	1.32m	1.39m
Height	0.99m	0.99m
Cut Height Range	20 - 160mm	20 - 160mm
No. of Blade Spindles	4	4
Approx. Weight	643kg	685kg
Min PTO Output	37hp	45hp

*Minimum PTO Output is a guide only. Requirement varies with the type of work and the terrain.

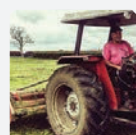

We use the Topper to keep up the quality of the grass behind the cows. The farm tends to grow a lot of grass early on in the season and it's hard to control, even with silage, so we top to keep the quality up. We get a nice clean cut which means you get good regrowth. I wouldn't buy anything else.
- IAN WILCOX | Farmer, Matamata, NZ

KEY APPLICATIONS.

✓ Dairy Farms ✓ Agriculture ✓ Aviation ✓ Racecourses

WHAT'S NEW ON TOPPER

The Topper is now fitted with an automatic belt tensioning system improving its performance in heavy conditions. Stand on covers bring added durability whilst providing safe and easy access to the rear of a tractor when coupling.

THE BENEFITS OF PASTURE TOPPING.

✓ Improves feed quality ✓ Increases farm profitability ✓ Increases MS production ✓ Promotes faster re-growth



PRODUCT FEATURES.



EASIER MAINTENANCE

New latch system provides easier access to drive system and access to roller bearing grease nipple has been improved.



AUTOMATIC BELT TENSIONER

Eliminates the need for belt adjustments and improves drive to the spindles and blades in longer grass.



STAND ON BELT COVERS

Provides safe and easy access to the rear of tractor when coupling.



ACCURATE HEIGHT SYSTEM

Height indicators are clearly displayed allowing for accurate and easy in field height adjustments



LOW HP REQUIREMENTS

Open deck design for grass processing, efficient belt drive system and a short mower front to rear allows for use on lower HP tractors.



LAZERBLADEZ™

Available in uplift and flat formation to suit mowing requirements, the unique tilt forward design minimises hang back in tough conditions.



ADVANCED DESIGN

Short front to rear and mounting close to the tractor allowing better manoeuvrability. High under body clearance and open deck design for increased grass production.



REAR ROLLER

The Topper is fitted with a rear roller, which ensures that in undulating environments you'll have increased protection from scalping.

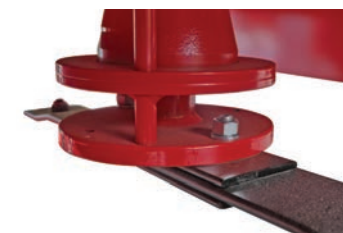

ANTI-BLOCK SYSTEM

High tensile spindles feature anti-wrap pins preventing frustrating blockages around spindles in extreme conditions.

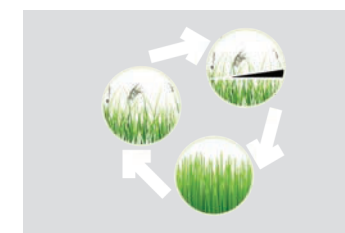

IMPROVES FEED QUALITY

Topping controls poor quality pasture components such as seed-heads and thistles and prevents their reoccurrence.



HIGH SPINDLE SPEEDS

More spindles, higher spindle speeds and shorter blade beams yield more cuts per forward meter of travel resulting in clean cut pasture.

VIEW MORE PHOTOS, VIDEOS, AND INFORMATION ABOUT THE TRIMAX TOPPER SERIES 3 ONLINE HERE:



TRIMAX FURY



**EXCEPTIONAL
TOUGHNESS,
LOW MAINTENANCE
BRILLIANCE.**

TRIMAX FURY

The Fury is our latest offering to the Horticulture market, a commercially built gear driven rotary mower which delivers market leading cut quality and reliability in tough, long grass conditions.

With over 40 years of experience in Horticulture, the Trimax Fury draws on years of customer insights and design experience to provide the ultimate gear driven rotary mower for the horticulture industry.

With the ability to provide rear or side discharge, and a range of roller or castor options, the Fury is one of our most adaptable mowers, allowing you to choose how you maintain your orchard.

The Fury incorporates Trimax's low maintenance design philosophy with our fully sealed Titan roller bearing and our unique coupling design which allows coupling's to be replaced easily without needing to remove gearboxes.

Backed by industry leading support and service, the Fury is the machine you need for inter-row orchard and vineyard management.

**TALK TO US TODAY ABOUT THE CAPABILITIES
OF FURY IN YOUR ENVIRONMENT.**

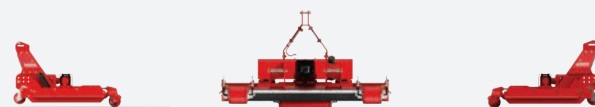

SPECIFICATIONS	160	180	200
Cutting Width	1.6m (5'3")	1.8m (5' 10 7/8")	2m (6' 6 11/16")
Overall Width	1.72m (5' 7 11/16")	1.92m (6' 3 5/8")	2.12m (6' 11 1/2")
Overall Length	1.71m (5' 7 5/16")	1.81m (5' 11 5/16")	1.91m (6' 3 3/4")
Height	1.15m (3' 9 3/8")	1.15m (3' 9 3/8")	1.15m (3' 9 3/8")
Cut Height Range	20 - 100mm (3/4 - 4")	20 - 100mm (3/4 - 4")	20 - 100mm (3/4 - 4")
No. of Rotors	2	2	2
Approx. Weight	610kg (1345lbs)	658kg (1450lbs)	733kg (1616lbs)
Min PTO Output	50hp	60hp	65hp

*Minimum PTO output is a guide only. Requirement varies with the type of work and the terrain

KEY APPLICATIONS.

✓ Horticulture ✓ Viticulture

INDUSTRY LEADING WARRANTY

3
YEAR
2 YEAR WARRANTY
FOR GEARBOXES
EXPERIENCED SERVICE
& SUPPORT NETWORK

PRODUCT FEATURES.



TITAN ROLLER BEARING SYSTEM

The Trimax Titan roller bearing system is maintenance-free and requires no greasing.



LOW MAINTENANCE

Zero daily maintenance requirements with the inclusion of the Titan roller bearing. Focus more on mowing and less on maintenance.



DURABLE DESIGN

A 10mm body reinforced with 10mm stiffeners around the gearbox mountings.



DISCHARGE VERSATILITY

Side and rear discharge options are available to suit mowing requirements.



UNIQUE COUPLING ASSEMBLY

Our unique coupling assembly means the rubber coupling can be easily replaced without having to remove gearboxes.



ENDURABLES

Endurablades are a heavy-duty blade with significant uplift, resulting in a clean cut in long grass conditions.



OVERRUN SLIP CLUTCH

Slip clutch comes standard to provide additional protection to the drive system in heavy conditions.



ANTI-BLOCK SYSTEM

Antiwrap pins are included to prevent material becoming wrapped in the driveline.

*OPTIONAL FEATURES.

✓ HEAVY DUTY BODY

A 15mm body reinforced with 10mm stiffeners around the gearbox mountings.

✓ HEAVY DUTY ROLLERS

Increases wall thickness from 6mm to 13mm for tough conditions.

✓ REAR CASTOR WHEELS

Rear castors are available to suit terrain and soil conditions.

✓ ROLLER SCRAPERS

Cleans rollers and reduces clumping in wet conditions.

**VIEW MORE PHOTOS, VIDEOS, AND INFORMATION
ABOUT THE TRIMAX FURY ONLINE HERE:**



TRIMAX STEALTH/S3



**MARKET LEADING
CUT, FINISH AND
VERSATILITY.**

TRIMAX STEALTH/S3

The STEALTH SERIES 3 has been designed to give a higher quality of cut, operate in a wider range of conditions, be safer, more robust, easier to operate and take less time to maintain than any previous STEALTH.

Backed by 30 years' of experience in market, the concept of Stealth Series 3 was born from the demand of our Australian customers for a mower that was more versatile in terms of long grass performance and more user friendly for both the operator and the workshop.

Backed by our industry leading 3-year warranty and our parts and technical support team, we know the Stealth Series 3 to be the best linkage wing mower for passive and active turf in the market.

**TALK TO US TODAY ABOUT THE
CAPABILITIES OF STEALTH SERIES 3
IN YOUR ENVIRONMENT.**



SPECIFICATIONS

340

Cutting Width	3.4m (11' 2")
Overall Width	3.55m (11' 8")
Transport Width	2.42m (7' 11")
Overall Length	1.63m (5' 4")
Height (wings up)	1.21m (3' 11½")
Cut Height Range	10 - 90mm (¾" - 3½")
No. of Blade Spindles	5
Approx. Weight	940kg (2070lbs)
Min PTO Output	70hp

**Minimum PTO output is a guide only. Requirement varies with the type of work and the terrain*



"The Stealth has brilliant decks with excellent grass dispersion and minimal greasing required. We can just jump in and cut grass!"

- ROSS HAMNER | Downer, Auckland, NZ

KEY APPLICATIONS.

✓ Municipal & Contractors ✓ School & Sports Fields ✓ Racecourses ✓ Aviation ✓ Lifestyle & Estates

WHAT'S NEW ON STEALTH/S3

We've reduced the need for greasing through the introduction of new features such as SteadFast maintenance-free spindles and composite maintenance-free bushes. Stealth wing locks can now be operated from inside the tractor cab. Modifications have been made to the cutting chamber and the baffle design for improved cut quality and easy cleaning.

PRODUCT FEATURES.

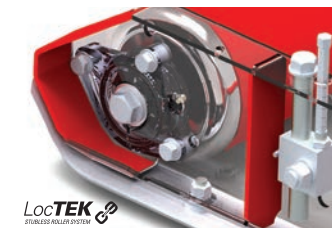

LOCTEK

A stubless roller bearing system for vastly improved roller retention, alignment, bearing life and minimal maintenance.



LOW MAINTENANCE

Reduced greasing requirements mean operators can spend more time mowing and less on maintenance.



LAZERBLADEZ™

Available in up-lift and flat formation to suit mowing requirements, the unique tilt forward design minimises hang back in tough conditions.



GREATER MOWING VERSATILITY

The improved cutting chamber and baffle design directs airflow from the blades out and over the rear roller for a better cut and spread.



EASY TO CLEAN

The improved belt chamber design results in easy cleaning, with the front openings allowing any grass to be easily washed out or removed.

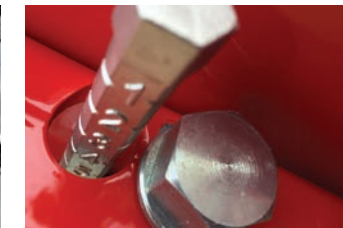

EASY HEIGHT ADJUSTMENT

Clearly displayed stainless steel height indicators allow the easy adjustment of cut heights without having to raise or lower the wings and deck.



ANTI-WEAR SKIDS

Anti-wear skids reduce wear on side channels when operating in rough or uneven terrain.

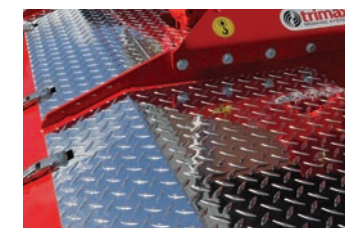

STAND ON COVERS

Enables safe and easy access to the rear of the tractor when coupling to the mower. Quick release latches allow easy removal for cleaning and servicing.



*OPTIONAL FEATURES.

✓ ROLLER SCRAPERS

Cleans rollers and reduces clumping in wet conditions.

✓ QUATTRO BLADES

Four blades (flat, upturned or mixed) per spindle for a finer cut.

✓ SERVICE STANDS

Lockable stands for safe underside access.

✓ LIGHTING KIT WITH STORAGE BRACKET

LED road lights, safety triangle, and bracket for storage box.

✓ STORAGE BOX

Easy access to spare parts and tools.

✓ GALVANIZED SURFACE COATING

Protect against corrosion in harsh environments.

✓ ELECTRIC UNLOCK

Upgrade to electric actuation for the mower wings' transport lock.

**VIEW MORE PHOTOS, VIDEOS, AND INFORMATION
ABOUT THE TRIMAX STEALTH SERIES 3 ONLINE HERE:**



TRIMAX STEALTH S3 SR



**PURPOSE BUILT FOR
ROADSIDE, OPEN SPACE
AND LONG GRASS
APPLICATIONS.**

TRIMAX STEALTH S3 SR

The Trimax STEALTH SR combines the cut quality, safety, robustness, decreased maintenance time, and easy operation of STEALTH SERIES 3 with enhanced performance in long grass.

With even more versatility than the Stealth Series 3 for long grass applications, the Stealth SR is purpose-built for an excellent cut for grass up to 500mm. The cutting chamber and baffle design are optimised to provide a better finish and spread at higher cut heights.

New and improved design features make the Stealth SR safer, more operator friendly, and easier to maintain than ever.



SPECIFICATIONS	340
Cutting Width	3.4m (11' 2")
Overall Width	3.55m (11' 8")
Transport Width	2.42m (7' 11")
Overall Length	1.63m (5' 4")
Height (wings up)	1.21m (3' 11½")
Cut Height Range	40 - 90mm (1½" - 3½")
No. of Blade Spindles	5
Approx. Weight	900kg (1984lbs)
Min PTO Output	60hp

*Minimum PTO output is a guide only. Requirement varies with the type of work and the terrain

**TALK TO US TODAY ABOUT THE
CAPABILITIES OF STEALTH S3 SR
IN YOUR ENVIRONMENT.**

KEY APPLICATIONS.

- ✓ Passive Turf & Open Space
- ✓ Municipal & Contractors
- ✓ Racecourses
- ✓ Aviation
- ✓ Horticulture
- ✓ Lifestyle & Estates

WHAT'S NEW ON STEALTH S3 SR

The Stealth SR incorporates all the new features of the Stealth S3. An anti-scalp roller on the front of the main mowing deck and bubble rollers on the wings are added to protect against scalping over contours.

*** INDUSTRY LEADING WARRANTY

3
YEAR

INCLUDES SPINDLES
& GEARBOXES

EXPERIENCED SERVICE
& SUPPORT NETWORK

PRODUCT FEATURES.

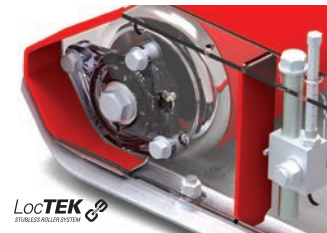

LOCTEK

A stubless roller bearing system for vastly improved roller retention, alignment, bearing life and minimal maintenance.



LONG GRASS PERFORMANCE

Designed to mow grass up to 500mm high and achieve the quality cut you expect from Trimax.



LAZERBLADEZ™

Available in up-lift and flat formation to suit mowing requirements, the unique tilt forward design minimises hang back in tough conditions.



ANTI-SCALP ROLLER

A raised front roller provides anti-scalp protection for your turf without impacting long grass performance.



EASY TO CLEAN

The improved belt chamber design results in easy cleaning, with the front openings allowing any grass to be easily washed out or removed.



EASY HEIGHT ADJUSTMENT

Clearly displayed stainless steel height indicators allow the easy adjustment of cut heights without having to raise or lower the wings and deck.



IN-CAB UNLOCK SYSTEM

Unlock the mower wings' transport lock from the convenience of the tractor seat using the tractor's hydraulic control lever.



LOW MAINTENANCE

Reduced greasing requirements mean operators can spend more time mowing and less on maintenance.

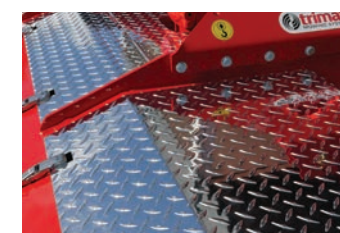

STAND ON COVERS

Enables safe and easy access to the rear of the tractor when coupling to the mower. Quick release latches allow easy removal for cleaning and servicing.

*OPTIONAL FEATURES.

✓ ROLLER SCRAPERS

Cleans rollers and reduces clumping in wet conditions.

✓ SERVICE STANDS

Lockable stands for safe underside access.

✓ LIGHTING KIT WITH STORAGE BRACKET

LED road lights, safety triangle, and bracket for storage box.

✓ STORAGE BOX

Easy access to spare parts and tools.

✓ GALVANIZED SURFACE COATING

Protect against corrosion in harsh environments.

✓ ELECTRIC UNLOCK

Upgrade to electric actuation for the mower wings' transport lock.

**VIEW MORE PHOTOS, VIDEOS, AND INFORMATION
ABOUT THE TRIMAX STEALTH SR ONLINE HERE:**



TRIMAX SNAKE S3

THE TURF SPECIALIST'S
SECRET WEAPON.



TRIMAX SNAKE S3

The Trimax Snake sets the standard for trailed rotary mowing, trusted by many prestigious golf courses and turf farms worldwide.

Studied by the Sports Turf Institute of New Zealand, the Trimax cutting system delivers cut quality comparable to cylinder mowers, while offering the versatility and reliability of Trimax's renowned rotary design.

Now, with zero daily maintenance, the Snake S3 makes operations even more efficient for turf professionals. The Snake S3 features the Titan roller bearing system and maintenance-free wheel hubs, which together eliminate the need for daily greasing. These innovations further reduce the cost of ownership allowing owners and operators to focus on what matters most – mowing.

Backed by Trimax's industry-leading 3-year warranty, the Snake S3 redefines productivity and operational efficiency.

TALK TO US TODAY ABOUT THE CAPABILITIES
OF SNAKE SERIES 3 IN YOUR ENVIRONMENT.



SPECIFICATIONS	320	400
Cutting Width	3.20m (10' 7")	4.00m (13' 1")
Overall Width	3.36m (11' 1")	4.12m (13' 6")
Overall Length	3.60m (11' 10")	3.60m (11' 10")
Transport Width	2.14m (7' 1/4")	2.14m (7' 1/4")
Transport Height	1.86m (6' 1")	2.24m (7' 4")
Cut Height Range	10 - 100mm (3/8" - 4")	10 - 100mm (3/8" - 4")
No. of Blade Spindles	9	11
Approx. Weight	1350kg (2976lbs)	1480kg (3258lbs)
Min PTO Output	35hp	45hp

*Minimum PTO output is a guide only. Requirement varies with the type of work and the terrain



It's one of my favourite mowers. Maintenance is an absolute breeze and the service from Trimax has been brilliant. I would recommend this mower to any country club or golf course.

- SIMON ASKEY Head Green Keeper, Whangamata Golf Club

KEY APPLICATIONS.

- ✓ Golf Courses (Roughs & Fairways) ✓ Municipal & Contractors ✓ Turf ✓ School & Sports Fields
- ✓ Lifestyle & Estates

WHAT'S NEW ON SNAKE S3

The Snake S3 builds on the Snake legacy with Trimax Titan roller bearings and maintenance-free wheel hubs for zero daily maintenance. New features also include height adjustment collars, stand-on covers, and removable blade beams for easy operation—letting turf professionals focus on exceptional results.

PRODUCT FEATURES.



TITAN ROLLER BEARING SYSTEM
The Trimax Titan roller bearing system is maintenance-free, requiring no regular greasing, and provides excellent retention.



ZERO DAILY MAINTENANCE
Implementation of the Trimax Titan roller bearing system and maintenance-free wheel hubs results in no daily maintenance.



AUTOMATIC BELT TENSIONERS
Automatic belt tensioners eliminate the need for belt adjustments and provides consistent drive to the spindles and blades.



ARTICULATION ABILITY
With three articulating decks the Snake has the ability to provide a consistent cut when contours are present.



FULL WIDTH ROLLERS
Full width rollers minimise scalping in undulating conditions, allowing for mowing over kerbsides and bunkers, while leaving a premium striped finish.



QUIKLIFT
QuikLIFT enables decks to be raised slightly for traversing paths without the need to disengage the PTO.



ZERO TURN
Allows continuous cutting while turning sharply for maximum productivity.



EASE OF USE
The Snake's compact design allows easy towing, new collars simplify height adjustment, and removable blade beams ensure easy blade changes.



LAZERBLADEZ™
LazerBladeZ offer a superior finish with a cost-efficient design, as only the fling-tip needs replacing. Available in uplift and flat formations, their tilt-forward design minimizes hang-back in tough conditions.



*OPTIONAL FEATURES.

- ✓ **ANTI-BOUNCE / WEAR SKIDS**
Eliminates scalping and bouncing and reduces side channel wear.
- ✓ **ROAD RATED TYRES**
Tow at highway speeds on the road.
- ✓ **ROLLER SCRAPERS**
Cleans rollers and reduces clumping in wet conditions.
- ✓ **ELECTRIC UNLOCK**
Unlocks decks electronically from the tractor seat.
- ✓ **MUDGUARDS, LIGHTS, & CHAINS**
Add LED tail light clusters, safety chains, and transport wheel mudguards for increased safety during road transportation.
- ✓ **MULCH KIT**
Save on purchasing dedicated leaf blowing and collection units with the Snake Mulch Kit.
- ✓ **NEXABLADES**
Scientifically designed for high-end turf giving a superior cut and spread when it matters most.
- ✓ **MULTI LIFT SYSTEM**
Five different lift functions to adjust mowing widths when required.
- ✓ **TRIMAX CONNECT**
A free app available when Trimax Multi-Lift System (MLS) is fitted. Provides mower runtime analysis and controls MLS functionality.

VIEW MORE PHOTOS, VIDEOS, AND INFORMATION
ABOUT THE TRIMAX SNAKE SERIES 3 ONLINE HERE:



TRIMAX PEGASUS//S5



**STRONGER.
SMARTER.
SAFER.
SECOND TO NONE.**

TRIMAX PEGASUS//S5

The Trimax Pegasus sets the benchmark in wide area mowing for parks, reserves, airports, racecourses, sports fields, turf farms, and more.

For over 20 years, the Trimax Pegasus has been leading the way in wide-area mowing. Introduced in 2001 as the world's first multi-deck roller mower, the Pegasus is renowned for its robustness and versatility. Its fast spindle speeds and deep mowing decks deliver the highest quality cut and finish every time, and articulating decks provide a consistent cut over light to moderate contours.

The Pegasus S5 builds on the incredible strength, durability, versatility, and efficiency of the previous series to increase machine life and decrease downtime in full-time commercial applications.

TALK TO US TODAY ABOUT THE CAPABILITIES OF TRIMAX PEGASUS S5 IN YOUR ENVIRONMENT.



SPECIFICATIONS	493	610	722
Cutting Width	4.94m (16' 2")	6.09m (19' 11")	7.23m (23' 9")
Overall Width	5.1m (16' 9")	6.25m (20' 6")	7.39m (24' 3")
Overall Length	4.65m (15' 3")	4.65m (15' 3")	4.65m (15' 3")
Transport Width	2.53m (8' 3¾")	2.53m (8' 3¾")	2.53m (8' 3¾")
Transport Height	2.62m (8' 7")	3.2m (10' 6")	3.8m (12' 6")
Cut Height Range	10 - 110mm (¾" - 4½")	10 - 110mm (¾" - 4½")	10 - 110mm (¾" - 4½")
No. of Blade Spindles	9	11	13
Approx. Weight	2200kg (4895lbs)	2440kg (5380lbs)	2660kg (5865lbs)
Min PTO Output	50hp	55hp	60hp

*Minimum PTO output is a guide only. Requirement varies with the type of work and the terrain

KEY APPLICATIONS.

✓ Municipal & Contractors ✓ Turf ✓ Racecourses ✓ Polo ✓ School & Sport Fields

WHAT'S NEW ON PEGASUS//S5

The Pegasus chassis and outrigger arms have been completely redesigned to increase strength without adding unnecessary weight. Larger wheels decrease ground pressure and support a wider range of tyre options. Maintenance-free features have been introduced.

PRODUCT FEATURES.



ROBUST CHASSIS

10% stronger under tough travel conditions, twice the durability in deck lifting and lowering, and a 60% increase in rigidity in the outrigger arms from Pegasus S4.



LOW MAINTENANCE

Zero daily greasing for an 80% reduction in annual grease consumption. Spindles, roller bearings, and auto-belt tensioning are maintenance-free.



TITAN ROLLER BEARING SYSTEM

The Trimax Titan roller bearing system is maintenance-free, requiring no regular greasing, and provides excellent retention.



IMPACT PROTECTION

Outrigger arms and side channel leading edges have been redesigned for increased impact protection.



QUIKLIIFT

Enables mower decks to be raised without disengaging the PTO to traverse driveways, footpaths and pavements. Now a standard inclusion for all Pegasus models.



SAFETY COMPLIANT

Complies with international safety standards and can be used with confidence on the roads and in public spaces.



SUSPENSION

The new Pegasus S5 Flexiride Torque Suspension System is designed for increased strength and smoother travel at highway speeds.



HEIGHT ADJUSTMENT

Clearly displayed indicators in both metric and imperial units and a high-tensile 2mm pitch adjuster for precise cut height alterations.



STAND ON BELT COVERS

Provides safe and easy access to the chassis.

*OPTIONAL FEATURES.

✓ **ANTI-BOUNCE / WEAR SKIDS**
Eliminates scalping and bouncing and reduces side channel wear.

✓ **ROLLER SCRAPERS**
Cleans rollers and reduces clumping in wet conditions.

✓ **QUATTRO BLADE SYSTEM**
Four blades (flat, upturned or mixed) per spindle for a finer cut.

✓ **ELECTRIC UNLOCK**
Unlocks decks electronically from the tractor seat.

✓ **MULTI-LIFT SYSTEM**
Five different lift functions for mower decks. Now with Drive Protect.

✓ **TURF TYRES**
Distributes mower weight for less ground disturbance.

✓ **SPARE ROAD TYRE & MOUNT**
Mounts a spare wheel to the rear mowing deck.

✓ **STORAGE KIT**
Mounts a toolbox to the mower chassis.

✓ **GALVANIZED**
Protect against corrosion in harsh environments.

✓ **ELECTRIC BRAKES WITH BREAKAWAY**
Reduces braking force required by the tractor.

✓ **ROAD KIT**
Adds lights, signage, and beacons to the mower.

✓ **TURF MUDGUARDS**
Available for both road tyres and turf tyres.

✓ **NEXABLADES**
Scientifically designed for high-end turf giving a superior cut and spread when it matters most.



VIEW MORE PHOTOS, VIDEOS, AND INFORMATION ABOUT THE TRIMAX PEGASUS SERIES 5 ONLINE HERE:



TRIMAX PEGASUS S5 SR



**WIDE AREA,
OPTIMAL LONG
GRASS PERFORMANCE.**

TRIMAX PEGASUS S5 SR

Since its introduction in 2001, the Trimax Pegasus series has established itself as the benchmark in wide-area mowing where cut quality and presentation are key. The Pegasus SR builds on the Pegasus's legendary versatility and cut quality by taking its long grass performance to another level.

The Pegasus SR variant allows larger volumes of grass to enter the deck by replacing the front roller with castor wheels, allowing the mower to tackle long grass more effectively.

Containing all the industry leading features included with the Pegasus S5, the Pegasus SR has a range of features that increase machine life, reduce maintenance, and decrease downtime in full-time commercial applications.

Built with industry leading strength and durability, the Pegasus SR is the machine you need for any commercial wide area long grass applications.

TALK TO US TODAY ABOUT THE CAPABILITIES OF TRIMAX PEGASUS S5 SR IN YOUR ENVIRONMENT.



SPECIFICATIONS	493	610	722
Cutting Width	4.94m (16' 2")	6.09m (19' 11")	7.23m (23' 9")
Overall Width	5.1m (16' 9")	6.25m (20' 6")	7.39m (24' 3")
Overall Length	4.65m (15' 3")	4.65m (15' 3")	4.65m (15' 3")
Transport Width	2.53m (8' 3 3/4")	2.53m (8' 3 3/4")	2.53m (8' 3 3/4")
Transport Height	2.62m (8' 7")	3.2m (10' 6")	3.8m (12' 6")
Cut Height Range	20 - 180mm (7/8" - 7 1/2")	20 - 180mm (7/8" - 7 1/2")	20 - 180mm (7/8" - 7 1/2")
No. of Blade Spindles	9	11	13
Approx. Weight	2300kg (5071lbs)	2500kg (5512lbs)	2700kg (5952lbs)
Min PTO Output	50hp	55hp	60hp

*Minimum PTO output is a guide only. Requirement varies with the type of work and the terrain

KEY APPLICATIONS.

- ✓ Passive Turf & Open Space
- ✓ Municipal & Contractors
- ✓ Aviation
- ✓ Racecourses

INDUSTRY LEADING WARRANTY

3 YEAR INCLUDES SPINDLES & GEARBOXES
EXPERIENCED SERVICE & SUPPORT NETWORK

PRODUCT FEATURES.



LONG GRASS PERFORMANCE

Designed to mow grass up to 500mm high (depending on conditions) with a cut height range of 20 - 180mm.



SINGLE ROLLER

Replacing the front roller with castor wheels allows more grass into the cutting chamber, resulting in a clean cut in long grass.



TITAN ROLLER BEARING SYSTEM

The Trimax Titan roller bearing system is maintenance-free, requiring no regular greasing, and provides excellent retention.



AUTOMATIC BELT TENSIONING

Provides more drive to the spindles in long grass applications.



IMPACT PROTECTION

Outrigger arms and side channel leading edges have been redesigned for increased impact protection.



QUIKLIFT

Enables mower decks to be raised without disengaging the PTO to traverse driveways, footpaths and pavements. Now a standard inclusion for all Pegasus models.



SAFETY COMPLIANT

Complies with international safety standards and can be used with confidence on the roads and in public spaces.



ROBUST CHASSIS

10% stronger under tough travel conditions, twice the durability in deck lifting and lowering, and a 60% increase in rigidity in the outrigger arms from Pegasus S4.



LOW MAINTENANCE

Zero daily greasing for an 80% reduction in annual grease consumption. Spindles, roller bearings, and auto-belt tensioning are maintenance-free.



SUSPENSION

The new Pegasus S5 Flexiride Torque Suspension System is designed for increased strength and smoother travel at highway speeds.

*OPTIONAL FEATURES.

- ✓ **REAR ROLLER SCRAPER**
Cleans rollers and reduces clumping in wet conditions.
- ✓ **QUATTRO BLADE SYSTEM**
Four blades (flat, upturned or mixed) per spindle for a finer cut.
- ✓ **ELECTRIC UNLOCK**
Unlocks decks electronically from the tractor seat.
- ✓ **TURF TYRES**
Distributes mower weight for less ground disturbance.
- ✓ **SPARE ROAD TYRE & MOUNT**
Mounts a spare wheel to the rear mowing deck.
- ✓ **STORAGE KIT**
Mounts a toolbox to the mower chassis.
- ✓ **ELECTRIC BRAKES WITH BREAKAWAY**
Reduces braking force required by the tractor.
- ✓ **ROAD KIT**
Adds lights, signage, and beacons to the mower.
- ✓ **TURF MUDGUARDS**
Available with turf tyre option.

VIEW MORE PHOTOS, VIDEOS, AND INFORMATION ABOUT THE TRIMAX PEGASUS SERIES 5 ONLINE HERE:



TRIMAX X-WAM



**THE ULTIMATE IN WIDE
AREA MOWING WHEN
QUALITY COUNTS.**



TRIMAX X-WAM

The X-WAM has superior contour-following abilities based on the unique combination of five individual floating decks on an articulated axis.

With the potential to cut 13 hectares per hour and the ability to perform zero-turns without having to lift any of the mower decks, the X-WAM will increase your productivity and efficiency using only one tractor, one driver, and one mower.

Providing an even discharge of clippings and with the ability to mow in wet conditions and produce a cylinder-like patterned finish, X-WAM is the ultimate wide area mower.

**TALK TO US TODAY ABOUT THE
CAPABILITIES OF TRIMAX X-WAM
IN YOUR ENVIRONMENT.**



SPECIFICATIONS	10400
Cutting Width	10.41m (34' 2")
Overall Width	10.54m (34' 7")
Overall Length	5.83m (19' 1")
Transport Width	2.74m (9')
Transport Height	4.45m (14' 7")
Cut Height Range	10 - 100mm (3/8" - 4")
No. of Blade Spindles	19
Approx. Weight	4880kg (10759lbs)
Min PTO Output	90hp

*Minimum PTO output is a guide only. Requirement varies with the type of work and the terrain

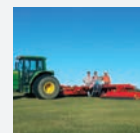

Trimax X-WAM is great equipment. It replaced one tractor, one employee and reduced mowing time. Less equipment to maintain and less equipment expense has increased our profitability.

- LYNN GIBB | Hope Plantation Turf, Texas USA

KEY APPLICATIONS.

✓ Turf / Sod Farm

WHAT'S NEW ON X-WAM

The X-WAM is Trimax's widest mower, with 5 full-sized mowing decks. It is available as a complete model or as a kit to add to the Trimax Pegasus 610. The decks can be retracted for transport.

INDUSTRY LEADING WARRANTY

**3
YEAR**

INCLUDES SPINDLES
& GEARBOXES
EXPERIENCED SERVICE
& SUPPORT NETWORK

PRODUCT FEATURES.

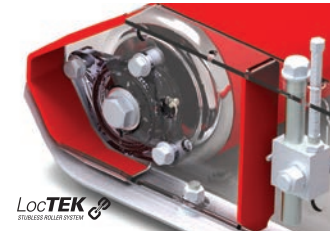

LOCTEK

A stubless roller bearing system for vastly improved roller retention, alignment, bearing life and minimal maintenance.



WHEELS RUN ON CUT GRASS

As the rear deck is located between the rear transport wheels, grass is not flattened by wheels prior to mowing, a feature unique to Trimax.



TURF TYRE

Trimax Turf Tyres help distribute the weight of the mower for less ground disturbance. Recommended for Turf Farms or fine turf applications.



FULL HYDRAULIC OPERATION

The X-WAM uses full hydraulic operation for deck retraction into road transport mode.



LOW MAINTENANCE

All moving surfaces have long life synthetic bushes or greasable bearings and remote grease points for hassle-free maintenance.



ULTIMATE CONTOUR FOLLOWING

Contour following and cut quality is compromised when decks are over 3m wide. The X-WAM features multiple smaller decks for superior cut quality.

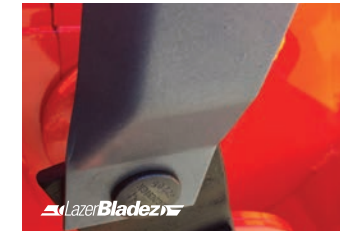

LAZERBLADEZ™

Available in uplift and flat formation to suit mowing requirements, the unique tilt forward design minimises hang back in tough conditions.



RAPIDSET HEIGHT ADJUSTMENT

Clearly displayed stainless steel height indicators allow the easy adjustment of cut heights without having to raise or lower the wings.



STEADFAST SEALED SPINDLES

We've eliminated the tedious task of regular greasing. Covered by our 3-year warranty, maintenance costs are reduced, and productivity is enhanced.

*OPTIONAL FEATURES.

✓ ANTI-BOUNCE / WEAR SKIDS

Eliminates scalping and bouncing and reduces side channel wear.

✓ ROLLER SCRAPERS

Cleans rollers and reduces clumping in wet conditions.

✓ QUATTRO BLADES

Four blades (flat, upturned or mixed) per spindle for a finer cut.

✓ GALVANIZED SURFACE COATING

Protect against corrosion in harsh environments.

✓ NEXABLADES

Scientifically designed for high-end turf giving a superior cut and spread when it matters most.

**VIEW MORE PHOTOS, VIDEOS, AND INFORMATION
ABOUT THE TRIMAX X-WAM ONLINE HERE:**



TRIMAX FLAILDEK FX

KEY APPLICATIONS.

- ✓ Municipal & Contractors
- ✓ School & Sports Fields
- ✓ Golf & Country Clubs (Roughs)
- ✓ Lifestyle & Estates
- ✓ Racecourses
- ✓ Horticulture

WHAT'S NEW ON FLAILDEK FX

Strength and durability are increased from the original FlailDek design with the incorporation of a high tensile steel body, a 70% stronger rotor, a stronger gearbox, and forged steel Trimax Gamma Flails. The unique converter has also been added.

INDUSTRY LEADING WARRANTY

3
YEAR

INCLUDES SPINDLES & GEARBOXES
EXPERIENCED SERVICE & SUPPORT NETWORK



TRIMAX FLAIL
TECHNOLOGY
FOR OUT FRONT
OPERATION.

TRIMAX FLAILDEK FX

The Trimax FlailDek FX offers a high-performance alternative to standard factory-fitted rotary mowing attachments.

FlailDek FX has the ability to deliver an exceptionally clean cut and disperse clippings safely and is used by contractors, councils, schools and land owners around the world. A highly versatile mower, FlailDek FX is also able to mulch branches up to 25mm in diameter, mow high grass and using the unique converter flap is suitable for sports fields and other fine turf applications.

The FlailDek FX has been designed to have minimal maintenance requirements and a low total cost of ownership yet deliver maximum reliability.

TALK TO US TODAY ABOUT THE CAPABILITIES OF FLAILDEK FX IN YOUR ENVIRONMENT.



SPECIFICATIONS	135	155	185
Cutting Width	1.36m (4' 6")	1.52m (5')	1.83m (6')
Overall Width	1.56m (5' 1½")	1.72m (5' 8")	2.05m (6' 8½")
Overall Length	1.1m (3' 7")	1.1m (3' 7")	1.1m (3' 7")
Overall Height	0.37m (1' 2½")	0.37m (1' 2½")	0.37m (1' 2½")
Cut Height Range	20 - 100mm (¾" - 4")	20 - 100mm (¾" - 4")	20 - 100mm (¾" - 4")
Approx. Weight	210kg (460lbs)	225kg (495lbs)	250kg (550lbs)
Total Belts	2	2	2
No. of Flails	28	32	40
Min PTO Output	N/A	N/A	N/A

*Minimum PTO output is a guide only. Requirement varies with the type of work and the terrain



This year I could not have coped without anything other than a Trimax FlailDek, it's versatile, cuts rough and fine grass even in the wet conditions and copes with it easily.

- ANDREW HALL | Truelink Ltd

PRODUCT FEATURES.



UNIQUE CONVERTER

Superb short grass cutting ability by creating airflow that lifts grass before it's cut. Open converter for increased productivity in long grass environments.



REAR ROLLER

Full width rear roller prevents scalping, permits the edge of the mower to be run along kerbs, adds to overall safety and produces striping.



POWER SAVING FLAILS

Strong forged steel flail with an aerodynamic profile reduces hp requirements yet generates sufficient draught to lift grass for a clean cut.



NEW IMPROVED ROTOR

Dynamically balanced and designed for durability to withstand everyday use in the toughest mowing environments.



SAFE CLIPPING DISPERSION

Safety is paramount when mowing in public areas. This is why Trimax has designed the FlailDek FX to expel debris in a downward direction behind the mower.



FRONT CASTOR WHEELS

Front castor wheels allow the FlailDek FX to follow ground contours independently from the tractor. The semi-pneumatic tires are impossible to puncture.



WEAR RESISTANT SKIDS

Wear resistant trailing skids made from abrasion-resistant steel extends bearing life and enables high productivity in the most challenging environments.

VIEW MORE PHOTOS, VIDEOS, AND INFORMATION ABOUT THE TRIMAX FLAILDEK FX ONLINE HERE:



TRIMAX EZEEMOW/FX



**TRIMAX FLAIL
TECHNOLOGY FOR
COMPACT TRACTORS.**

TRIMAX EZEEMOW/FX

The EZEEMOW FX is the ideal partner for your compact tractor where versatility and robustness is needed.

With its compact dimension, Ezeemow FX can fit closely to the tractor and manoeuvre into tight corners. Able to mow anything from fine turf to small prunings, vegetation up to 25mm in diameter and high grass, the Ezeemow FX can transform areas into tidy mown lawn in a single pass. This versatility makes the Ezeemow FX ideal for contractors, councils, roadsides, estates, and orchard applications.

The Ezeemow FX has been designed to have minimal maintenance requirements and low total cost of ownership yet deliver maximum reliability.

TALK TO US TODAY ABOUT THE CAPABILITIES OF EZEEMOW FX IN YOUR ENVIRONMENT.



SPECIFICATIONS	135	155	185
Cutting Width	1.36m (4' 6")	1.52m (5')	1.83m (6')
Overall Width	1.56m (5' 1 1/2")	1.72m (5' 8")	2.05m (6' 8 1/2")
Overall Length	0.58m (1' 11")	0.58m (1' 11")	0.58m (1' 11")
Overall Height	0.37m (1' 2 1/2")	0.37m (1' 2 1/2")	0.37m (1' 2 1/2")
Cut Height Range	10 - 100mm (3/8" - 4")	10 - 100mm (3/8" - 4")	10 - 100mm (3/8" - 4")
Approx. Weight	180kg (396lbs)	200kg (440lbs)	225kg (495lbs)
Total Belts	2	2	2
No. of Flails	28	32	40
Min PTO Output	17hp	20hp	24hp

*Minimum PTO output is a guide only. Requirement varies with the type of work and the terrain



I've been mowing 30hrs a week for over 28 years and my Ezeemow still has the same gearbox. It produces a beautiful cut and if I had to, I'd replace it with the exact same model...no two ways about it!

- STEVE DE BRUIN | Grass Cutting Services, Tauranga NZ

KEY APPLICATIONS.

- ✓ Municipal & Contractors
- ✓ Horticulture
- ✓ Lifestyle & Estates

WHAT'S NEW ON EZEEMOW FX

Strength and durability are increased from the original Ezeemow design with the incorporation of a high tensile steel body, a 70% stronger rotor, a stronger gearbox, and forged steel Trimax Gamma Flails. The unique converter, an improved belt tensioning system, and easy height adjustment on the full width roller have also been added.

PRODUCT FEATURES.



UNIQUE CONVERTER

Superb short grass cutting ability by creating airflow that lifts grass before it's cut. For work in heavy environments, lift converter for increased productivity. The Converter flap is an optional add on.



SAFE CLIPPING DISPERSION

Safety is paramount when mowing in public areas. This is why Trimax has designed the Ezeemow FX to expel debris in a downward direction behind the mower.



POWER SAVING FLAILS

Strong forged steel flail with an aerodynamic profile reduces hp requirements yet generates sufficient draught to lift grass for a clean cut.



*RIGHT-HAND OFFSET

Comes standard with a centre mount but is available in a right-hand offset to suit your specific mowing requirements.



REAR ROLLER

Full width rear roller prevents scalping, permits the edge of the mower to be run along kerbs, adds to overall safety and produces striping.



NEW IMPROVED ROTOR

Dynamically balanced and designed for durability to withstand everyday use in the toughest mowing environments.

EZEEMOW OFFSET DIAGRAM

ONLY AVAILABLE IN FIXED CENTRE MOUNT OR OFFSET POSITIONS

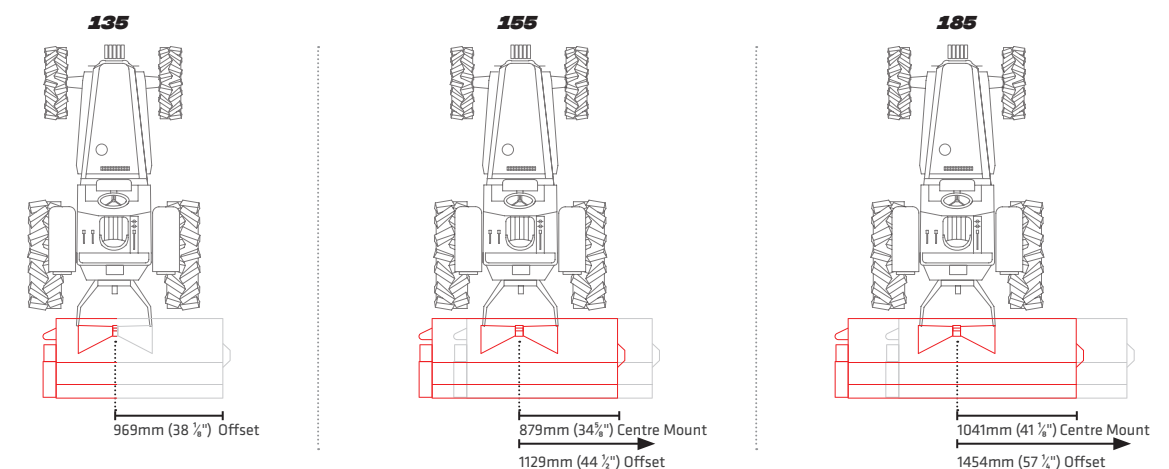

VIEW MORE PHOTOS, VIDEOS, AND INFORMATION ABOUT THE TRIMAX EZEEMOW FX ONLINE HERE:



TRIMAX FORCE



**A HIGH-UTILITY
HEAVY-DUTY
POWERHOUSE.**

TRIMAX FORCE

The Trimax Force is the multitool mower and mulcher you need to get the job done, no matter what that job might be. Turn long grass and large prunings into an expertly cut and finely mulched field in a single pass.

As Trimax's strongest and most adaptable flail mower yet, with a wide range of options available for custom configuration, the Force can easily be tailored to produce a pristine cut and superior finish in almost any application. For reliable productivity and excellent results, the Trimax Force is the ultimate choice.

TALK TO US TODAY ABOUT THE CAPABILITIES OF THE TRIMAX FORCE IN YOUR ENVIRONMENT.



SPECS	115	145	175	205	235
Cutting Width	1.15m (3' 9 1/4")	1.44m (4' 8 3/4")	1.73m (5' 8 1/8")	2.02m (6' 7 3/8")	2.3m (7' 6 3/8")
Overall Width	1.45m (4' 8 7/8")	1.73m (5' 8 1/8")	2.02m (6' 7 3/8")	2.31m (7' 7")	2.59m (8' 5 7/8")
Overall Length	1.15m (3' 9 1/4")	1.15m (3' 9 1/4")	1.15m (3' 9 1/4")	1.15m (3' 9 1/4")	1.15m (3' 9 1/4")
Overall Height	0.5m (1' 7 3/4")	0.5m (1' 7 3/4")	0.5m (1' 7 3/4")	0.5m (1' 7 3/4")	0.5m (1' 7 3/4")
Cut Height Range	0 - 60mm (0 - 2 3/8")	0 - 60mm (0 - 2 3/8")	0 - 60mm (0 - 2 3/8")	0 - 60mm (0 - 2 3/8")	0 - 60mm (0 - 2 3/8")
Approx. Weight	590kg (1300lbs)	650kg (1435lbs)	755kg (1665lbs)	815kg (1795lbs)	870kg (1920lbs)
Flails	16	20	24	28	32
Min PTO Output	30hp	35hp	40hp	45hp	50hp

*Minimum PTO Output is a guide only. Requirement varies with the type of work and the terrain.

KEY APPLICATIONS.

✓ Municipal & Contractors ✓ Horticulture ✓ Aviation ✓ Racecourses ✓ Lifestyle & Estates

WHAT'S NEW ON FORCE.

Strength and durability have been increased, including 50% thicker endplates and a newly designed rotor bearing assembly with over 35% higher load capacity than Trimax's previous flail mowers. Zero-maintenance features and a wider array of options have also been introduced.

INDUSTRY LEADING WARRANTY

3
YEAR

INCLUDES SPINDLES & GEARBOXES
EXPERIENCED SERVICE & SUPPORT NETWORK

PRODUCT FEATURES.



MOW AND MULCH WITH ONE MACHINE

Mow grass to a fine finish and mulch prunings up to 90mm in diameter with one machine.



REPLACEABLE INTERNAL LINER

A 6mm replaceable internal liner reduces noise and increases durability in the mower's high-impact zones.

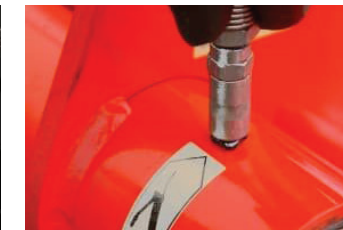

LOW MAINTENANCE

Easily accessible grease locations and maintenance-free features make regular service quicker and easier than ever.



DISCHARGE CONTROL

The coarseness of mulch can be controlled by adjusting the height of the rear flap.



OFFSET CAPABILITIES

The Force can come with a left- or right-hand offset with an additional 500mm of hydraulic side shift. Available on the 175, 205, and 235 models.

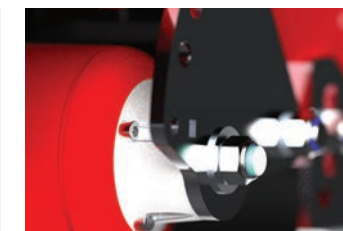

MAINTENANCE-FREE ROLLER BEARINGS

New highly-rated sealed roller bearing stacks require no regular greasing.



AUTO BELT TENSIONING

The belt system is equipped with automatic tensioners to optimize drive to the rotor without requiring manual adjustments.



SMOOTH EXTERNAL PROFILE

New internal rotor bearings create a smooth external profile and provide a closer cut around obstacles.



HEAVY-DUTY SKIDS

Heavy-duty wear skids on the mower trailing arms prolong mower life in demanding terrain and are easily removed or replaced.

*OPTIONAL FEATURES.

- ✓ **HEAVY DUTY LINER**
Increases durability in the mower's high impact zone.
- ✓ **HEAVY DUTY ROLLER**
Increases roller wall thickness from 5mm to 11mm.
- ✓ **ROLLER SCRAPERS**
Cleans rollers and reduces clumping in wet conditions.
- ✓ **MULCHING COUNTERBLADES**
Produces an ultra-fine mulch.
- ✓ **PRUNING RAKES**
Collects prunings into the cutting chamber.
- ✓ **LIGHTING KIT WITH STORAGE BRACKET**
LED road lights, safety triangle, and bracket for storage box.
- ✓ **STORAGE BOX**
Easy access to spare parts and tools.
- ✓ **SAFETY DISPERSION GUARD**
Recommended for all mowers operating in public spaces, the Safety Dispersion Guard ensures that debris exits the cutting chamber safely.
- ✓ **FRONT MOUNT**
Available in front mount three-point linkage configuration for increased visibility.

VIEW MORE PHOTOS, VIDEOS, AND INFORMATION ABOUT THE TRIMAX FORCE ONLINE HERE:



TRIMAX WARLORD S3

**YOUR ALL-PURPOSE
WORKING COMPANION.**



TRIMAX WARLORD S3

Extremely versatile, the Trimax WARLORD S3 is bound to dominate any environment you put it in – handling long and short grass, prunings up to 75mm in diameter, turf ribbons and offcuts with ease.

Tame rough patches full of scrub and branches in one pass and leave behind a field of evenly distributed mulch and clippings. Control the coarseness of discharge with Warlord's adjustable rear flap while safely dispersing clippings. The Trimax Warlord is tough and durable, requiring minimal maintenance and simplifying repairs to keep your machine running for years. Spend less time and money keeping your mower operating at 100%.

The Trimax Warlord S3 is a medium duty mower/mulcher suitable for a wide range of applications including sod and turf farming, horticulture, passive turf management, contracting/hire, and land reclamation.

**TALK TO US TODAY ABOUT THE
CAPABILITIES OF WARLORD SERIES 3
IN YOUR ENVIRONMENT.**



SPECIFICATIONS	175	205	235
Cutting Width	1.74m (5' 9")	2.04m (6' 8")	2.34m (7' 8")
Overall Width	2.04m (6' 8")	2.34m (7' 8")	2.66m (8' 8")
Overall Length	1.05m (3' 5")	1.05m (3' 5")	1.05m (3' 5")
Overall Height	0.55m (1' 10")	0.55m (1' 10")	0.55m (1' 10")
Cut Height Range	0 - 70mm (0 - 2¾")	0 - 70mm (0 - 2¾")	0 - 70mm (0 - 2¾")
Approx. Weight	690kg (1520lbs)	750kg (1650lbs)	810kg (1780lbs)
No. of Flails	24	28	32
Min PTO Output	40hp	44hp	49hp

*Minimum PTO output is a guide only. Requirement varies with the type of work and the terrain



We do a lot of roadside work for councils, shires and local government. We use the Warlord where it's too tough for other machines, from my past experience it stands head and shoulders above the rest.

- ALAN CHAPEL | AML Turf, Wodonga QLD

KEY APPLICATIONS.

✓ Horticulture ✓ Municipal & Contractors ✓ Turf ✓ Aviation ✓ Racecourses

WHAT'S NEW ON WARLORD S3

The hydraulic side shift and discharge control capabilities are new from the previous Warlord series, further increasing the versatility of the machine.

INDUSTRY LEADING WARRANTY

3
YEAR

INCLUDES SPINDLES
& GEARBOXES
EXPERIENCED SERVICE
& SUPPORT NETWORK

PRODUCT FEATURES.



HYDRAULIC SIDE SHIFT

The Warlord can be quickly offset to the right by up to 500mm. Perfect for transport and manoeuvring around obstacles whilst mowing.

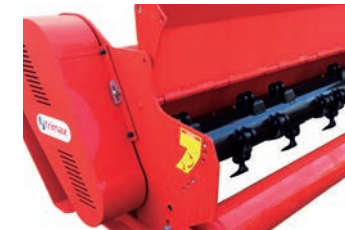

DISCHARGE CONTROL

Fine mulch is produced with the flap in the lowest position. Controlling discharge assists with safety in public spaces. Lift flap open for easy flail servicing.



PRUNING GUIDE

Helps direct prunings in and under the mower. Also helps keep debris away from the hydraulic system.

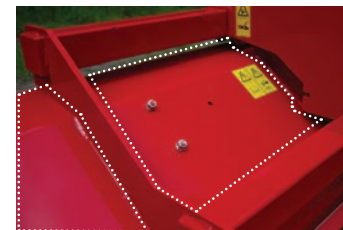

REPLACEABLE INTERNAL LINER

A bolt-in 6mm replaceable internal liner increases the life of the body, minimises damage and reduces noise.



REPLACEABLE SKIDS

Skids on Warlord trailing arms prolong mower life in demanding terrain and can be replaced when required.



RIGHT HAND OFFSET

Warlord is configured with right-hand offset for increased over-the-shoulder visibility.

*OPTIONAL FEATURES.

✓ ROLLER SCRAPERS

Cleans rollers and reduces clumping in wet conditions.

WARLORD OFFSET DIAGRAM

HYDRAULIC SIDE SHIFT /
RIGHT-HAND SIDE SHIFT
ONLY

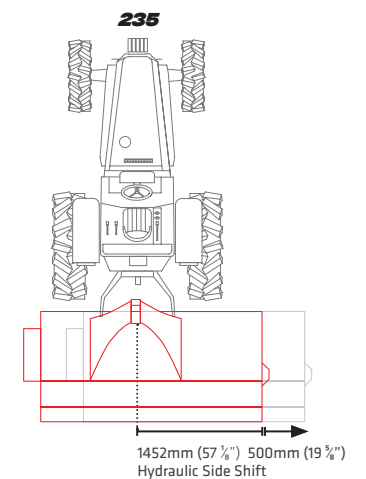
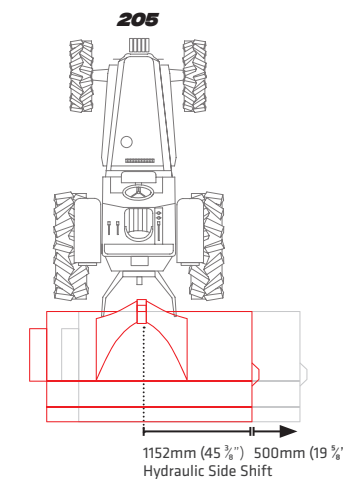
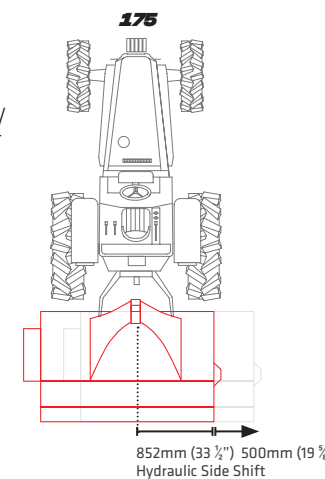

**VIEW MORE PHOTOS, VIDEOS, AND INFORMATION
ABOUT THE TRIMAX WARLORD SERIES 3 ONLINE HERE:**



WANT TO KNOW MORE?
**FIND US
ONLINE.**

**THE TRIMAX
WEBSITE.**

The Trimax website contains more information, photos, and videos of our products and features.

TRIMAXMOWERS.CO.NZ



OR USE THIS
QR CODE

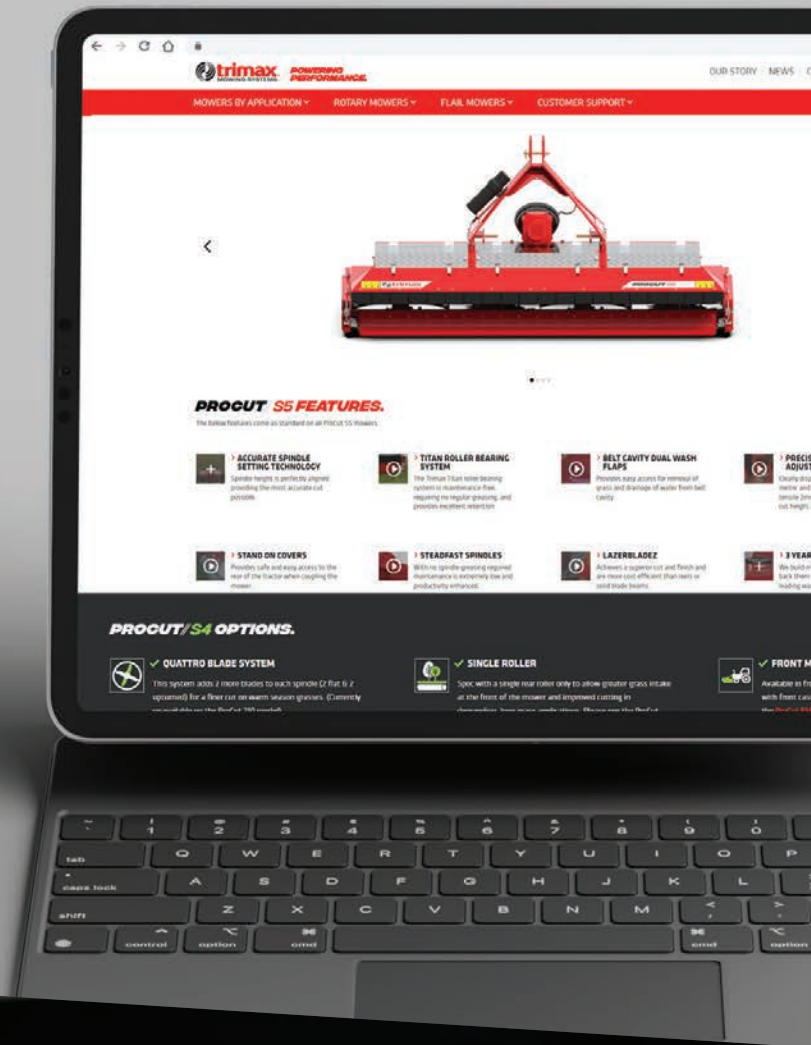

PASSIONATE ABOUT
**POWERING YOUR
PERFORMANCE.**

WHEN DOWNTIME IS NOT
AN OPTION, SAVE MONEY
ON EQUIPMENT THAT
LASTS. YOU CAN COUNT
ON TRIMAX.

**LOW TOTAL
COST OF OWNERSHIP.**

- › Long commercial life, with mowers 35 years old and counting still in the field.
- › Reduced time, labour, and fuel requirements for each job.
- › Affordable aftermarket parts guaranteed to meet Trimax quality standards.

**RELIABLE
SUPPORT.**

- › Next-day parts dispatch from our local warehouse in Tauranga.
- › Knowledgeable local service staff and easy-to-access online resources.
- › Industry-leading 3-year warranty which includes spindles and gearboxes.

**PRODUCTIVITY-BOOSTING
EFFICIENCY.**

- › Less time in the shop with minimised and simplified service requirements.
- › Designed for/tested in the harshest environments for maximum uptime in normal commercial operations.
- › A wide range of available options to customise for your specific needs.

**THE TRIMAX
RESOURCE CENTRE.**

Easily accessed from the main website, the Trimax Resource Centre provides everything you need to easily service and maintain your Trimax mower. Best of all, it's completely free.

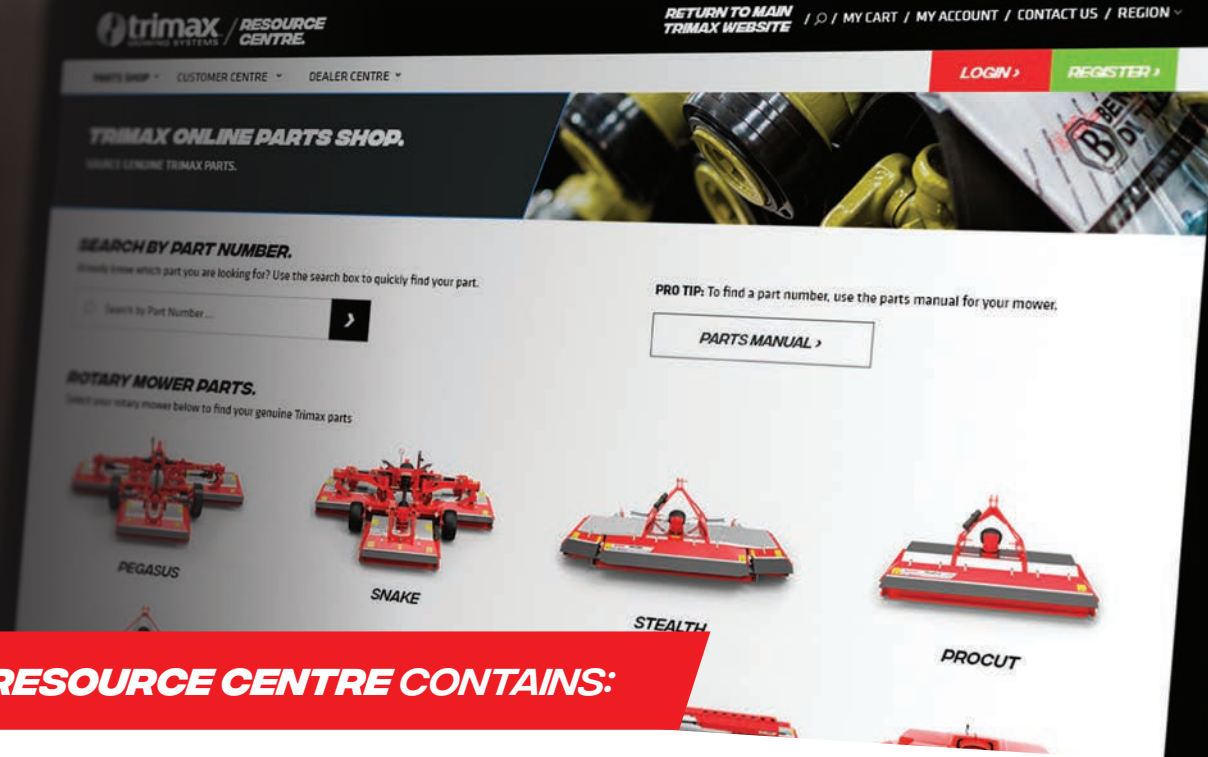

INDUSTRY-LEADING
3-YEAR WARRANTY.

TRIMAX BUILDS MOWERS
THAT LAST, AND WE BACK
THAT UP BY OFFERING
THE LONGEST AND
MOST COMPREHENSIVE
WARRANTY IN THE
INDUSTRY.

All Trimax mowers come with a standard 12-month warranty with the opportunity to extend another 24 months by registering new machines online.

- ✓ **COVERS SPINDLES**
- ✓ **COVERS GEARBOXES**
- ✓ **ABSOLUTELY FREE**

THE TRIMAX RESOURCE CENTRE CONTAINS:



**THE TRIMAX
CUSTOMER CENTRE.**

- ✓ Watch step-by-step service and setup videos.
- ✓ Download maintenance checklists.
- ✓ Access the operator manual and parts manual for your mower.
- ✓ Read instructions for installing Trimax Genuine Spare Parts.
- ✓ Register warranty or file a claim.



**THE TRIMAX
PARTS SHOP.**

- ✓ Order Trimax Genuine Parts and Service Kits
- ✓ Review past orders.
- ✓ Upload bulk orders for quick and easy fleet maintenance.
- ✓ Quickly find common parts.
- ✓ Now with improved search functionality – find exactly the part you need.





**DESIGNED &
MANUFACTURED IN**



TRIMAX MOWING SYSTEMS

70 Maleme Street, Tauranga 3140

P 07 541 0411 / **E** info@trimaxmowers.co.nz

FOR MOWER SALES

P 07 543 1892 / **E** info@trimaxmowers.co.nz

FOR PARTS ORDERS

P 07 543 1897 / **E** parts@trimaxmowers.co.nz



f X Instagram YouTube in v // TRIMAXMOWERS.CO.NZ